



MTP SINGLE-USE PRODUCTS

1st EDITION 1/2017

Chapter			Pages
1	NEUROSURGERY	NEURO-MTP	1-18
2	ORAL AND MAXILLOFACIAL SURGERY	OMFS-MTP	19-22
3	ENT	ENT-MTP	23-48
4	ANESTHESIOLOGY AND EMERGENCY MEDICINE	AN-MTP	49-58
5	THORAX	THOR-MTP	59-64
6	SYSTEMS FOR GASTROENTEROLOGY	GE-MTP	65-78
7	LAPAROSCOPY IN SURGERY, GYNECOLOGY, UROLOGY	LAP-MTP	79-112
8	GYNECOLOGY	GYN-MTP	113-132
9	UROLOGY	URO-MTP	133-154
10	PROCTOLOGY	PRO-MTP	155-160
11	ARTHROSCOPY AND SPORTS MEDICINE	ART-MTP	161-188
12	SPINE SURGERY	CV-MTP	189-198
13	MICROSCOPY	MICRO-MTP	199-202
14	TELEPRESENCE	TP-MTP	203-208
15	UNITS AND ACCESSORIES	UNITS-MTP	209-242
16	NAVIGATION	NAV-MTP	243-246
17	HYGIENE	HYG-MTP	247-250
18	KARL STORZ OR1 NEO®, TELEPRESENCE HYGIENE, ENDOPROTECT1		



THE WORLD OF ENDOSCOPY



Information on events is available on the KARL STORZ website
www.karlstorz.com

MTP SINGLE-USE PRODUCTS

1st EDITION 1/2017

Important Notes:

It is recommended to check the suitability of the product for the intended procedure prior to use.

Endoscopes and accessories contained in this catalog have been designed in part with the cooperation of physicians and are manufactured by the KARL STORZ group. If subcontractors are hired to manufacture individual components, these are made according to proprietary KARL STORZ plans or drawings. Furthermore, these products are subject to strict quality and control guidelines of the KARL STORZ group. Both contractual and general legal provisions prohibit subcontractors from supplying components manufactured by order of KARL STORZ to competitors.

Any assumptions that competitors' endoscopes and accessories are acquired from the same suppliers as the KARL STORZ products are not correct. Moreover, endoscopes and instruments provided by competitors are not manufactured according to the design specifications of KARL STORZ. This means it cannot be assumed that these endoscopes and accessories – even if they look identical on the outside – are constructed in the same manner and have been tested according to the same criteria.

Standardized Design and Labeling

KARL STORZ participates both in national and international bodies involved in the development of standards for endoscopes and endoscopic accessories. Standardized design and development therefore have long been implemented consistently by KARL STORZ. The user can rest assured that all products by the KARL STORZ group have been designed and constructed not only in compliance with strict internal quality guidelines, but also with international standards. All data relevant for safe use, such as viewing direction, sizes and diameters, or notes regarding sterilization of telescopes, are applied to the instruments, have been formulated according to international standards, and therefore provide reliable information.

As we constantly seek to improve and modify our products, we reserve the right to make changes in design that vary from catalog descriptions.

Original or Counterfeit

KARL STORZ products are name brand articles renowned around the world and represent the state of the art in important areas of healthcare. A large number of "copy cat" products are currently being offered in many markets. These products are designed intentionally to resemble KARL STORZ products and use marketing strategies that at least point out their compatibility with KARL STORZ products. These products are by no means genuine products, since genuine KARL STORZ products are sold worldwide exclusively under the name of KARL STORZ, which appears on the packaging and the product. In the absence of such labeling, the product is not from KARL STORZ.

KARL STORZ, therefore, is unable to ensure that such products are actually compatible with genuine KARL STORZ products or can be used with them without injury to the patient.



NEUROSURGERY

HIGH-SPEED BURRS 3-8

SHAVER BLADES,
SINUS BURRS 9-13

TUBING SETS 14-15

TAKE-APART®
BIPOLAR FORCEPS 16

CATHETERS, INJECTION NEEDLES 17

SPARE PARTS AND
ACCESSORIES 18

High-Speed Burrs

High-Speed Craniotome Burrs



For use with Craniotome Handpiece 252645 and Dura Protectors 252646, 252647, 252648



252645

	High-Speed Craniotome Burr, sterile, for single use, package of 5		
	short	medium	long
	360000 S	360000 M	360000 L
For use with	Dura Protector 252646	Dura Protector 252647	Dura Protector 252648

High-Speed Burrs

High-Speed Standard Burrs, High-Speed Diamond Burrs



For use with High-Speed Handpieces 252680 short, 252681 medium and 252682 long



Diameter in mm	High-Speed Standard Burr, 100,000 rpm, sterile, for single use, package of 5		
	short	medium	long
1	350110 S	350110 M	—
2	350120 S	350120 M	350120 L
3	350130 S	350130 M	350130 L
4	350140 S	350140 M	350140 L
5	350150 S	350150 M	350150 L
6	350160 S	350160 M	350160 L
7	350170 S	350170 M	350170 L

Diameter in mm	High-Speed Diamond Burr, 100,000 rpm, sterile, for single use, package of 5		
	short	medium	long
1	350210 S	350210 M	—
2	350220 S	350220 M	350220 L
3	350230 S	350230 M	350230 L
4	350240 S	350240 M	350240 L
5	350250 S	350250 M	350250 L
6	350260 S	350260 M	350260 L
7	350270 S	350270 M	350270 L

High-Speed Burrs

High-Speed Coarse Diamond Burrs, High-Speed Acorns,
High-Speed Barrel Burrs, High-Speed Neuro Fluted Burrs





For use with High-Speed Handpieces 252680 short, 252681 medium and 252682 long



252681

	High-Speed Coarse Diamond Burr, 100,000 rpm, sterile, for single use, package of 5		
Diameter in mm	short	medium	long
3	350330 S	350330 M	350330 L
4	350340 S	350340 M	350340 L
5	350350 S	350350 M	350350 L
6	350360 S	350360 M	350360 L
7	350370 S	350370 M	350370 L

	High-Speed Acorn, 100,000 rpm, sterile, for single use, package of 5	
Diameter in mm	short	medium
7.5	350675 S	350675 M
9	350690 S	350690 M

	High-Speed Barrel Burr, 100,000 rpm, sterile, for single use, package of 5	
Diameter in mm	short	medium
6	350960 S	350960 M
9.1	350991 S	350991 M

	High-Speed Neuro Fluted Burr, 100,000 rpm, sterile, for single use, package of 5		
Diameter in mm	short	medium	long
1.8	350718 S	350718 M	350718 L
3	350730 S	350730 M	350730 L

High-Speed Burrs

High-Speed Standard Burrs, High-Speed Diamond Burrs



For use with High-Speed Handpieces 252660 extra short, 252661 short, 252662 medium, 252663 long, 252690 extra short, 252691 short and 252692 medium



 Diameter in mm	High-Speed Standard Burr, 60,000 rpm, sterile, for single use, package of 5			
	extra short	short	medium	long
1	330110 ES	330110 S	330110 M	–
2	330120 ES	330120 S	330120 M	330120 L
3	330130 ES	330130 S	330130 M	330130 L
4	330140 ES	330140 S	330140 M	330140 L
5	330150 ES	330150 S	330150 M	330150 L
6	330160 ES	330160 S	330160 M	330160 L
7	330170 ES	330170 S	330170 M	330170 L

 Diameter in mm	High-Speed Diamond Burr, 60,000 rpm, sterile, for single use, package of 5			
	extra short	short	medium	long
0.6	330206 ES	330206 S	–	–
1	330210 ES	330210 S	330210 M	–
1.5	330215 ES	330215 S	–	–
2	330220 ES	330220 S	330220 M	330220 L
3	330230 ES	330230 S	330230 M	330230 L
4	330240 ES	330240 S	330240 M	330240 L
5	330250 ES	330250 S	330250 M	330250 L
6	330260 ES	330260 S	330260 M	330260 L
7	330270 ES	330270 S	330270 M	330270 L

High-Speed Burrs

High-Speed Coarse Diamond Burrs, High-Speed Cylinder Burrs,
LINDEMANN High-Speed Fluted Burrs



For use with High-Speed Handpieces 252660 extra short, 252661 short, 252662 medium, 252663 long, 252690 extra short, 252691 short and 252692 medium



 Diameter in mm	High-Speed Coarse Diamond Burr, 60,000 rpm, sterile, for single use, package of 5			
	extra short	short	medium	long
3	330330 ES	330330 S	330330 M	330330 L
4	330340 ES	330340 S	330340 M	330340 L
5	330350 ES	330350 S	330350 M	330350 L
6	330360 ES	330360 S	330360 M	330360 L
7	330370 ES	330370 S	330370 M	330370 L

 Diameter in mm	High-Speed Cylinder Burr, 60,000 rpm, sterile, for single use, package of 5	
	extra short	short
4	330440 ES	330440 S
6	330460 ES	330460 S

 Size in mm (diameter x length)	LINDEMANN High-Speed Fluted Burr, 60,000 rpm, sterile, for single use, package of 5	
	extra short	short
Diameter 2.1/11	330511 ES	330511 S
Diameter 2.3/26	330526 ES	330526 S

High-Speed Burrs

High-Speed Diamond Burrs



For use with High-Speed Handpieces 252671 extra long and 252672 super long

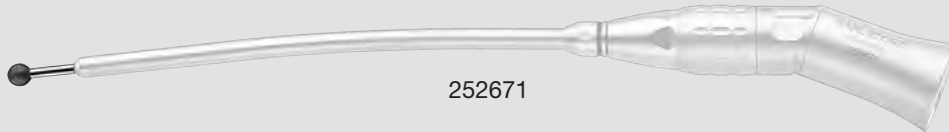

	High-Speed Diamond Burr, 60,000 rpm, sterile, for single use, package of 5	
Diameter in mm	extra long	super long
2	320220 EL	320220 SL
3	320230 EL	320230 SL
4	320240 EL	320240 SL

	High-Speed Coarse Diamond Burr, 60,000 rpm, sterile, for single use, package of 5	
Diameter in mm	extra long	super long
2	320320 EL	320320 SL
3	320330 EL	320330 SL
4	320340 EL	320340 SL

Shaver Blades

for surgery of the paranasal sinuses and anterior skull base



For use with DRILLCUT-X® II Shaver Handpiece 40 7120 50 and
DRILLCUT-X® II N Shaver Handpiece 40 7120 55

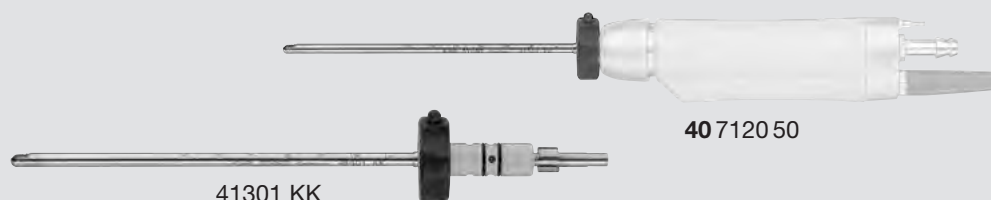

Detail	Shaver Blade, straight, length 12 cm, sterile, for single use, package of 5	
	41301 KN	serrated cutting edge, diameter 4 mm, color code: blue-red
	41301 KK	double serrated cutting edge, diameter 4 mm, color code: blue-yellow
	41301 GN	concave cutting edge, oval cutting window, diameter 4 mm, color code: blue-green
	41301 LN	concave cutting edge, oblique cutting window, diameter 4 mm, color code: blue-black
	41301 SN	straight cutting edge, diameter 4 mm, color code: blue-blue
	41301 KSA	serrated cutting edge, diameter 3 mm, color code: blue-red
	41301 KKSA	double serrated cutting edge, diameter 3 mm, color code: blue-yellow
	41301 KKSB	double serrated cutting edge, diameter 2 mm, color code: blue-yellow
	41301 LSA	concave cutting edge, oblique cutting window, diameter 3 mm, color code: blue-black

Shaver Blades

for surgery of the paranasal sinuses and anterior skull base



For use with DRILLCUT-X® II Shaver Handpiece 40 7120 50 and
DRILLCUT-X® II N Shaver Handpiece 40 7120 55

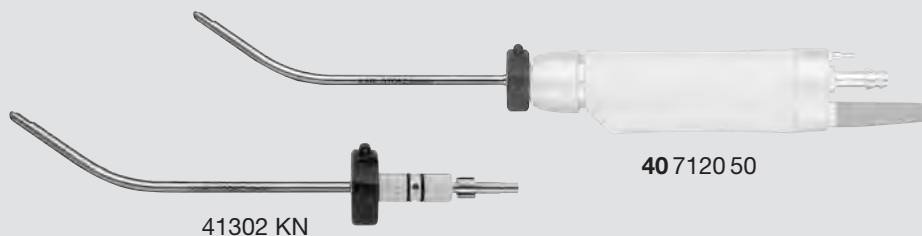

Detail	Shaver Blade, curved 35°/40°, length 12 cm, sterile, for single use, package of 5	
	41302 KN	curved 35°, cutting edge serrated backwards, single serrated, diameter 4 mm, color code: blue-red
	41304 KKF	curved 40°, cutting edge serrated forwards, double serrated, diameter 4 mm, color code: blue-yellow
	41304 KKB	curved 40°, cutting edge serrated backwards, double serrated, diameter 4 mm, color code: blue-yellow
	41304 KKFA	curved 40°, cutting edge serrated forwards, double serrated, diameter 3 mm, color code: blue-yellow
	41304 KKBA	curved 40°, cutting edge serrated backwards, double serrated, diameter 3 mm, color code: blue-yellow

Shaver Blades

for surgery of the paranasal sinuses and anterior skull base



For use with DRILLCUT-X® II Shaver Handpiece 40 7120 50 and
DRILLCUT-X® II N Shaver Handpiece 40 7120 55

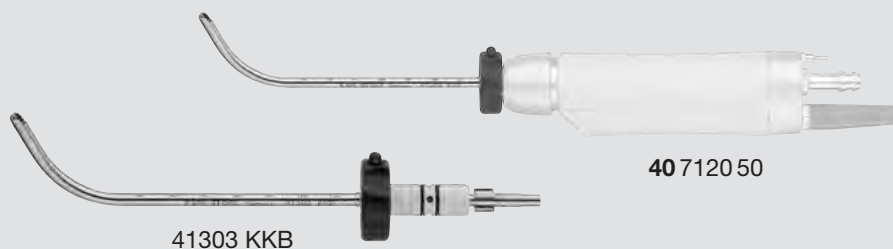

Detail	Shaver Blade, curved 65°, length 12 cm, sterile, for single use, package of 5	
	41303 KNF	curved 65°, cutting edge serrated forwards, single serrated, diameter 4 mm, color code: blue-red
	41303 KNB	curved 65°, cutting edge serrated backwards, single serrated, diameter 4 mm, color code: blue-red
	41303 KKF	curved 65°, cutting edge serrated forwards, double serrated, diameter 4 mm, color code: blue-yellow
	41303 KKB	curved 65°, cutting edge serrated backwards, double serrated, diameter 4 mm, color code: blue-yellow
	41303 KKFA	curved 65°, cutting edge serrated forwards, double serrated, diameter 3 mm, color code: blue-yellow
	41303 KKBA	curved 65°, cutting edge serrated backwards, double serrated, diameter 3 mm, color code: blue-yellow

Sinus Burrs

for surgery of the paranasal sinuses and anterior skull base



For use with DRILLCUT-X® II Shaver Handpiece 40 7120 50 and DRILLCUT-X® II N Shaver Handpiece 40 7120 55

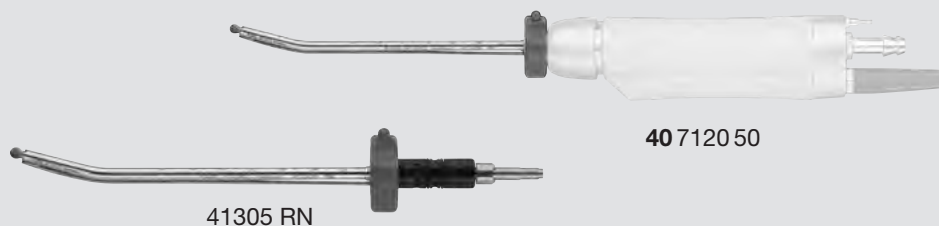

Detail	Sinus Burr, curved 70°/55°/40°/15°, length 12 cm, sterile, for single use, package of 5	
	41304 W	curved 40°, cylindrical, drill diameter 3 mm, shaft diameter 4 mm, color code: red-blue
	41303 WN	curved 55°, cylindrical, drill diameter 3.6 mm, shaft diameter 4 mm, color code: red-blue
	41305 RN	curved 15°, bud drill, drill diameter 4 mm, shaft diameter 4 mm, color code: red-black
	41305 DN	curved 15°, diamond head, drill diameter 3 mm, shaft diameter 4 mm, color code: red-yellow
	41305 D*	curved 15°, diamond head, drill diameter 5 mm, shaft diameter 4 mm, color code: red-yellow
	41305 DW*	curved 40°, diamond head, drill diameter 5 mm, shaft diameter 4 mm, color code: red-yellow
	41303 DT*	curved 70°, diamond head, drill diameter 3.6 mm, shaft diameter 4 mm, color code: red-yellow

* The above instruments are navigated sinus burrs. For further information on optical and electromagnetic navigation see chapter 16 NAVIGATION

Sinus Burrs 35 k

for surgery of the paranasal sinuses and anterior skull base



For use with DRILLCUT-X® II-35 Shaver Handpiece 40 7120 35 and
DRILLCUT-X® II-35 N Shaver Handpiece 40 7125 35

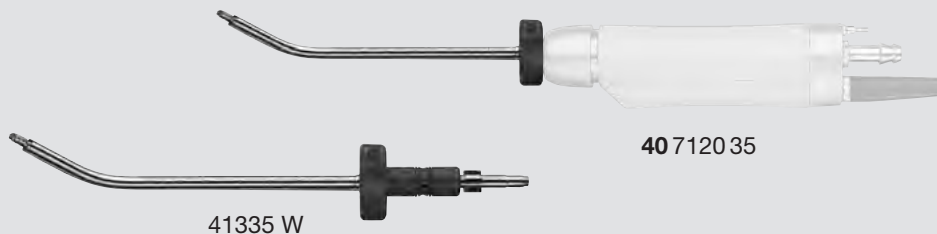

Detail	Sinus Burr 35 k, curved 70°/40°/15°, length 12 cm, sterile, for single use, package of 5	
	41335 W	curved 40°, cylindrical, drill diameter 3 mm, shaft diameter 4 mm, color code: red
	41335 RN	curved 15°, bud drill, drill diameter 4 mm, shaft diameter 4 mm, color code: red
	41335 DW*	curved 40°, diamond head, drill diameter 5 mm, shaft diameter 4 mm, color code: red
	41335 DT*	curved 70°, diamond head, drill diameter 3.6 mm, shaft diameter 4 mm, color code: red
	41335 DS	curved 40°, diamond head, drill diameter 4 mm, shaft diameter 4 mm, color code: red

* The above instruments are navigated sinus burrs. For further information on optical and electromagnetic navigation see chapter 16 NAVIGATION

Tubing Sets

Irrigation Tubing Sets



Special Features:

- No risk of confusion when placing the connectors
- Automatic product recognition and mode selection via the pump

For use with ENDOMAT® SELECT



031529-10

031529-10 **Tubing Set for Irrigation, CV, sterile, for single use, package of 10, for use with ENDOMAT® SELECT**

Tubing Sets

Irrigation Tubing Sets



For use with CLEARVISION®, UNIDRIVE® II plus, UNIDRIVE® ENT/ECO/NEURO, UNIDRIVE® S III ENT/ECO/NEURO and/or CLEARVISION® II

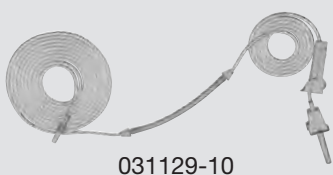

031129-10

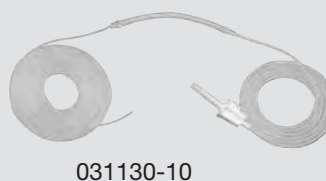

031130-10



031131-10



031229-10

- 031129-10 **Tubing Set**, sterile, for single use, package of 10, for use with CLEARVISION®
- 031130-10 **Tubing Set**, sterile, for single use, package of 10, for use with UNIDRIVE® II plus
- 031131-10 **Tubing Set**, sterile, for single use, package of 10, for use with UNIDRIVE® ENT/ECO/NEURO, UNIDRIVE® S III ENT/ECO/NEURO
- 031229-10 **Tubing Set**, sterile, for single use, package of 10, for use with CLEARVISION® II

TAKE-APART® Bipolar Forceps

Forcep Inserts



For use with TAKE-APART® Bipolar Forceps

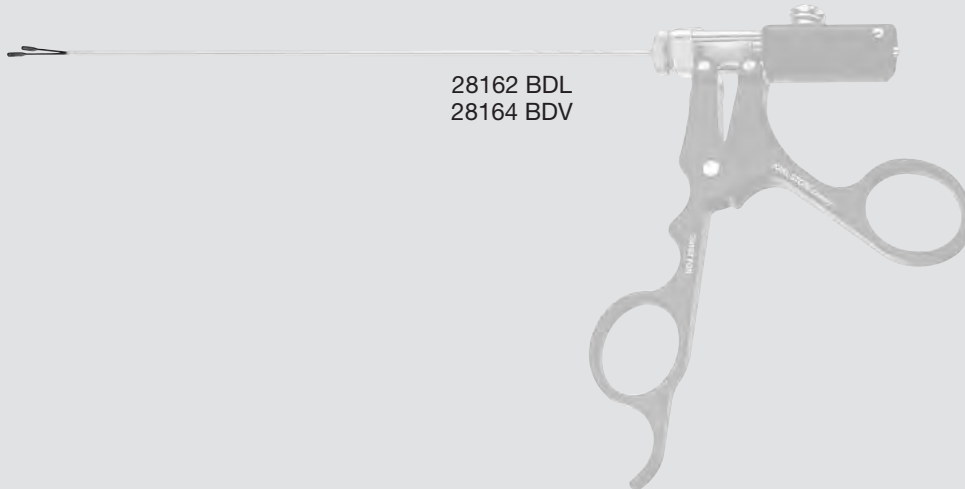

28162 BDL
28164 BDV



28162 FGL



28162 FGL

TAKE-APART® Forceps Insert, with flat jaws, size 2.4 mm, for single use, package of 5, for use with TAKE-APART® Bipolar Forceps 28162 BDL

28164 FGV

TAKE-APART® Forceps Insert, with flat jaws, size 2.4 mm, for single use, package of 5, for use with TAKE-APART® Bipolar Forceps 28164 BDV

Catheters, Injection Needles

Suction Catheters, Injection Needles



Suction Catheters

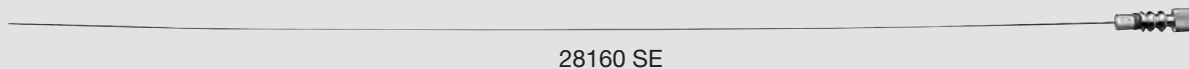

- 28160 SE **Suction Catheter**, flexible, diameter 1 mm, working length 45 cm, for single use
- 28160 SB **Same**, diameter 1.5 mm
- 28160 SF **Same**, diameter 2.5 mm

Injection Needles

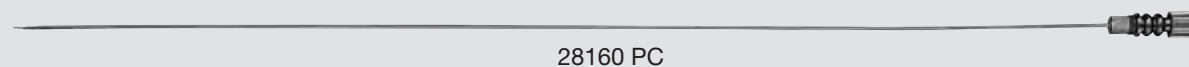

- 28160 PC **Injection Needle**, flexible, diameter 1.7 mm, working length 45 cm, for single use
- 28160 PD **Same**, diameter 2.5 mm

Spare Parts and Accessories

Push-Button Pressure Valves



For use with THUMFART Handle 723620 H and
IRO Handle 723622 H



723620 H



101010-10

Push-Button Pressure Valve, sterile,
for single use, package of 10



ORAL AND MAXILLOFACIAL SURGERY

STONE EXTRACTORS 20

GUIDE WIRES 21

CATHETERS 22

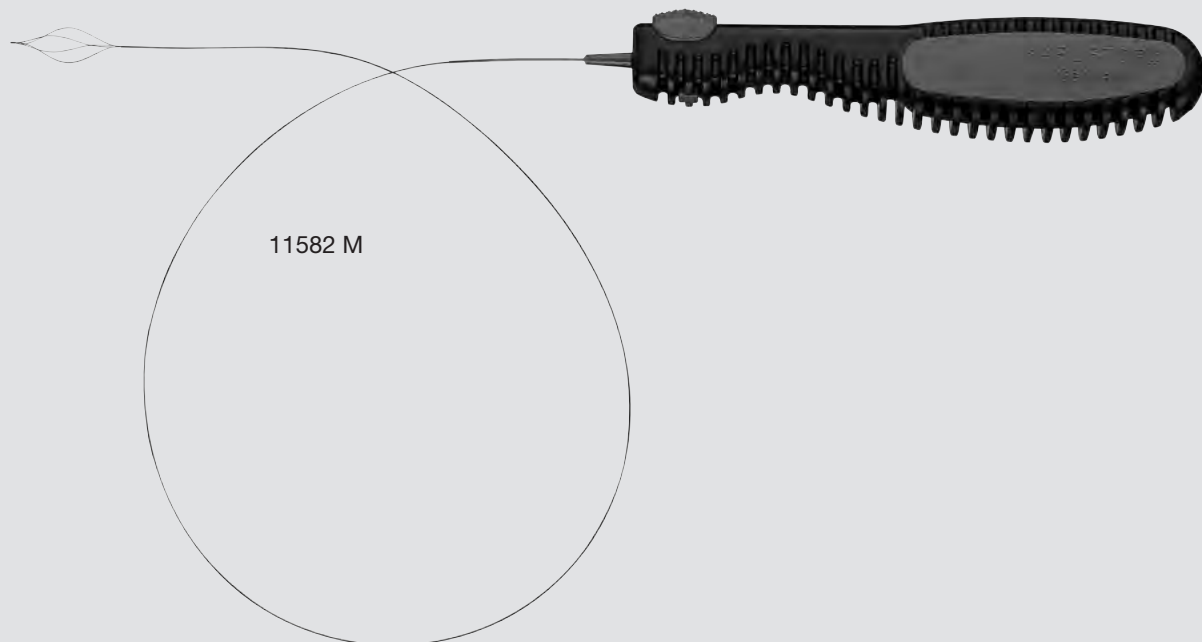

11575 K

Stone Extractor, diameter 0.6 mm, basket with 3 wires, sterile, for single use

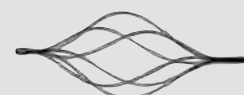

11575 L

Stone Extractor, diameter 0.6 mm, basket with 6 wires, sterile, for single use



11582 M

Stone Extractor, diameter 0.4 mm, basket with 4 wires, sterile, for single use



11573 NP

Front-loading Stone Extractor, without handle, diameter 0.4 mm, length 35 cm, basket with 4 wires, sterile, for single use, package of 10



11573 T

Stone Extractor, diameter 0.6 mm, basket with 4 wires, tipless, with handle for fixation to endoscope, sterile, for single use



11573 M

Stone Extractor, diameter 0.4 mm, basket with 4 wires, with handle for fixation to endoscope, sterile, for single use

Guide Wires



For use with Bougies 745710 – 745713

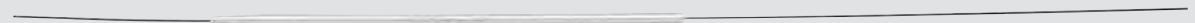

745711

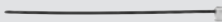

745720

Guide Wire, diameter 0.6 mm, sterile, for single use, package of 10, for use with Bougies 745710 – 745713

For use with Bougies 745708 – 745713



745725

Guide Wire, diameter 0.4 mm, sterile, for single use, package of 10, for use with Bougies 745708 – 745713

Catheters

Balloon Catheters



For use with Operating Sheaths 11576 KF and 11577 KE

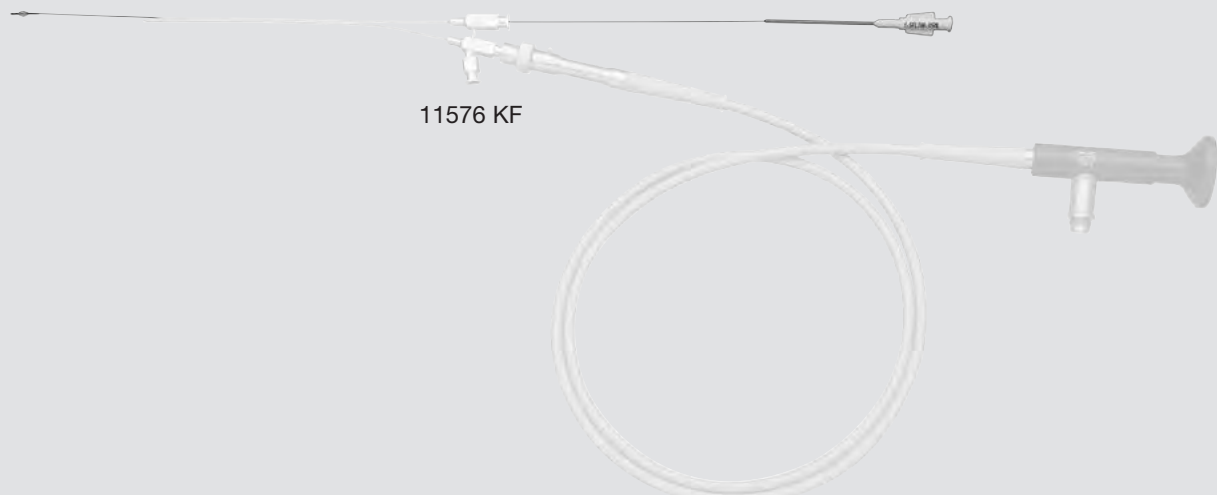

11576 KF



11577 BP

Balloon Catheter, diameter 0.9 mm, sterile, for single use, package of 10, for use with Operating Sheaths 11576 KF and 11577 KE

For use with Telescopes 11574 A and 11583 A

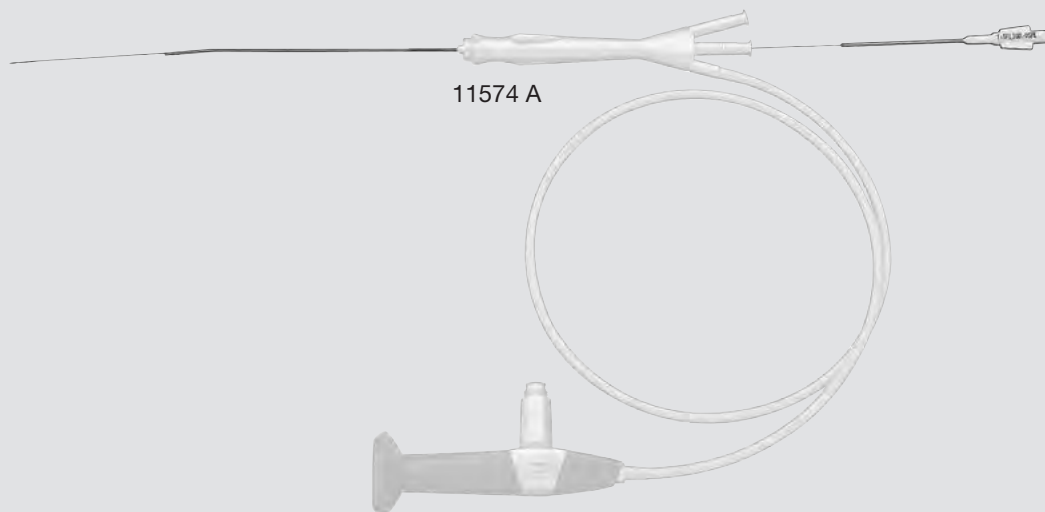

11574 A



11583 BP

Balloon Catheter, diameter 0.7 mm, sterile, for single use, package of 10, for use with Telescopes 11574 A and 11583 A



ENT

FLEXIBLE SINGLE-USE ^{NEW}
VIDEO ENDOSCOPES 24-25

HIGH-SPEED
BURRS 26-30

SHAVER BLADES,
SINUS BURRS 31-36

PROBES 37

INJECTION 38-39

TUBING SETS 40-41

SPARE PARTS AND
ACCESSORIES 42-47

Flexible Single-Use Video Endoscopes ^{NEW}



The flexible video endoscopes for single use provide a compact solution thanks to their integrated light source and camera control unit. The combination with our lightweight C-MAC® Monitor 8403 ZX and the E-Box

makes the flexible video endoscopes a mobile and straightforward solution for the hospital, your practice, home visits or for consultation purposes.

Special Features:

- Easy to install and lightweight, the flexible video endoscopes for single use in combination with the E-Box and the C-MAC® monitor provide optimal mobility
- Excellent image quality thanks to powerful LED
- Ergonomic handle design
- Lightweight and easy to use thanks to compact design and separate E-Box
- Integrated LED light source for optimal illumination
- Video and image capture as well as data storage via the C-MAC® monitor
- Always ready for use without delay



Flexible Single-Use Video Endoscopes ^{NEW}



For use with C-MAC® Monitor 8403 ZX and E-Box TP 010

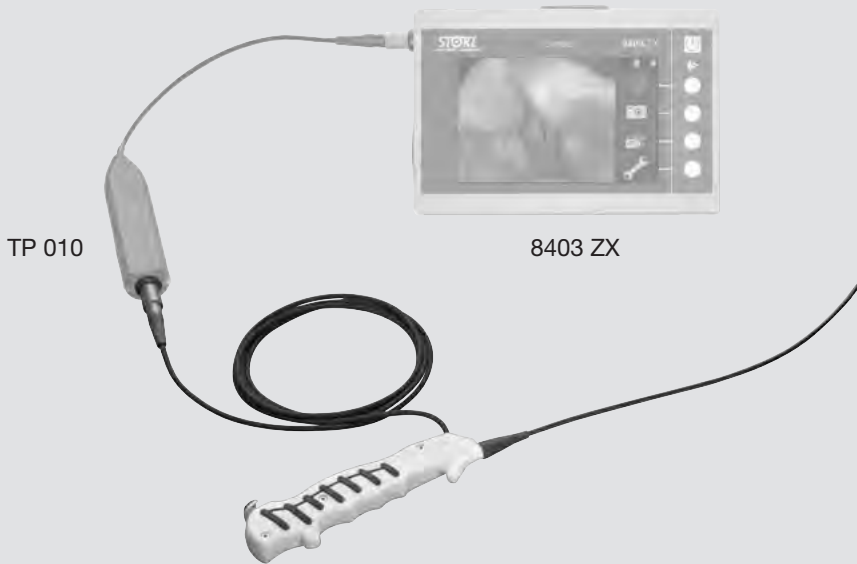

TP 010

8403 ZX



091330-06

091330-06 **Video Rhino-Laryngoscope**, sterile, for single use, package of 6, for use with E-Box TP 010

Direction of view:	0°
Angle of view:	90°
Working length:	30 cm
Outer diameter:	3.5 mm
Deflection up/down:	140°/140°

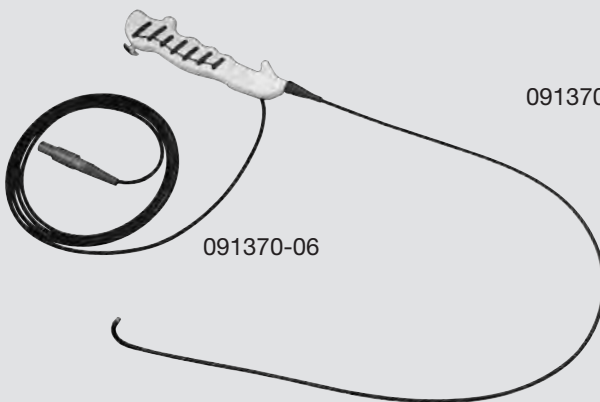

091370-06

091370-06 **Video Esophagoscope**, sterile, for single use, package of 6, for use with E-Box TP 010

Direction of view:	0°
Angle of view:	90°
Working length:	75 cm
Outer diameter:	3.5 mm
Deflection up/down:	210°/210°

High-Speed Burrs

High-Speed Standard Burrs, High-Speed Diamond Burrs



For use with High-Speed Handpieces 252680 short, 252681 medium and 252682 long



 High-Speed Standard Burr, 100,000 rpm, sterile, for single use, package of 5			
Diameter in mm	short	medium	long
1	350110 S	350110 M	—
2	350120 S	350120 M	350120 L
3	350130 S	350130 M	350130 L
4	350140 S	350140 M	350140 L
5	350150 S	350150 M	350150 L
6	350160 S	350160 M	350160 L
7	350170 S	350170 M	350170 L

 High-Speed Diamond Burr, 100,000 rpm, sterile, for single use, package of 5			
Diameter in mm	short	medium	long
1	350210 S	350210 M	—
2	350220 S	350220 M	350220 L
3	350230 S	350230 M	350230 L
4	350240 S	350240 M	350240 L
5	350250 S	350250 M	350250 L
6	350260 S	350260 M	350260 L
7	350270 S	350270 M	350270 L

High-Speed Burrs

High-Speed Coarse Diamond Burrs, High-Speed Acorns,
High-Speed Barrel Burrs, High-Speed Neuro Fluted Burr





For use with High-Speed Handpieces 252680 short, 252681 medium and 252682 long



252681

	High-Speed Coarse Diamond Burr, 100,000 rpm, sterile, for single use, package of 5		
Diameter in mm	short	medium	long
3	350330 S	350330 M	350330 L
4	350340 S	350340 M	350340 L
5	350350 S	350350 M	350350 L
6	350360 S	350360 M	350360 L
7	350370 S	350370 M	350370 L

	High-Speed Acorn, 100,000 rpm, sterile, for single use, package of 5	
Diameter in mm	short	medium
7.5	350675 S	350675 M
9	350690 S	350690 M

	High-Speed Barrel Burr, 100,000 rpm, sterile, for single use, package of 5	
Diameter in mm	short	medium
6	350960 S	350960 M
9.1	350991 S	350991 M

	High-Speed Neuro Fluted Burr, 100,000 rpm, sterile, for single use, package of 5		
Diameter in mm	short	medium	long
1.8	350718 S	350718 M	350718 L
3	350730 S	350730 M	350730 L

High-Speed Burrs

High-Speed Standard Burrs, High-Speed Diamond Burrs



For use with High-Speed Handpieces 252660 extra short, 252661 short, 252662 medium, 252663 long, 252690 extra short, 252691 short and 252692 medium



252661

	High-Speed Standard Burr, 60,000 rpm, sterile, for single use, package of 5			
	Diameter in mm	extra short	short	medium
1	330110 ES	330110 S	330110 M	–
2	330120 ES	330120 S	330120 M	330120 L
3	330130 ES	330130 S	330130 M	330130 L
4	330140 ES	330140 S	330140 M	330140 L
5	330150 ES	330150 S	330150 M	330150 L
6	330160 ES	330160 S	330160 M	330160 L
7	330170 ES	330170 S	330170 M	330170 L

	High-Speed Diamond Burr, 60,000 rpm, sterile, for single use, package of 5			
	Diameter in mm	extra short	short	medium
0.6	330206 ES	330206 S	–	–
1	330210 ES	330210 S	330210 M	–
1.5	330215 ES	330215 S	–	–
2	330220 ES	330220 S	330220 M	330220 L
3	330230 ES	330230 S	330230 M	330230 L
4	330240 ES	330240 S	330240 M	330240 L
5	330250 ES	330250 S	330250 M	330250 L
6	330260 ES	330260 S	330260 M	330260 L
7	330270 ES	330270 S	330270 M	330270 L

High-Speed Burrs

High-Speed Coarse Diamond Burrs, High-Speed Cylinder Burrs,
LINDEMANN High-Speed Fluted Burrs



For use with High-Speed Handpieces 252660 extra short, 252661 short, 252662 medium, 252663 long, 252690 extra short, 252691 short and 252692 medium



 Diameter in mm	High-Speed Coarse Diamond Burr, 60,000 rpm, sterile, for single use, package of 5			
	extra short	short	medium	long
3	330330 ES	330330 S	330330 M	330330 L
4	330340 ES	330340 S	330340 M	330340 L
5	330350 ES	330350 S	330350 M	330350 L
6	330360 ES	330360 S	330360 M	330360 L
7	330370 ES	330370 S	330370 M	330370 L

 Diameter in mm	High-Speed Cylinder Burr, 60,000 rpm, sterile, for single use, package of 5	
	extra short	short
4	330440 ES	330440 S
6	330460 ES	330460 S

 Size in mm (diameter x length)	LINDEMANN High-Speed Fluted Burr, 60,000 rpm, sterile, for single use, package of 5	
	extra short	short
Diameter 2.1/11	330511 ES	330511 S
Diameter 2.3/26	330526 ES	330526 S

High-Speed Burrs

High-Speed Diamond Burrs



For use with High-Speed Handpieces 252671 extra long and 252672 super long

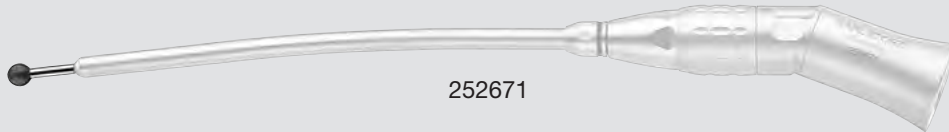

252671

	High-Speed Diamond Burr, 60,000 rpm, sterile, for single use, package of 5	
Diameter in mm	extra long	super long
2	320220 EL	320220 SL
3	320230 EL	320230 SL
4	320240 EL	320240 SL

	High-Speed Coarse Diamond Burr, 60,000 rpm, sterile, for single use, package of 5	
Diameter in mm	extra long	super long
2	320320 EL	320320 SL
3	320330 EL	320330 SL
4	320340 EL	320340 SL

Shaver Blades

for surgery of the paranasal sinuses and anterior skull base



For use with DRILLCUT-X® II Shaver Handpiece 40 7120 50 and
DRILLCUT-X® II N Shaver Handpiece 40 7120 55

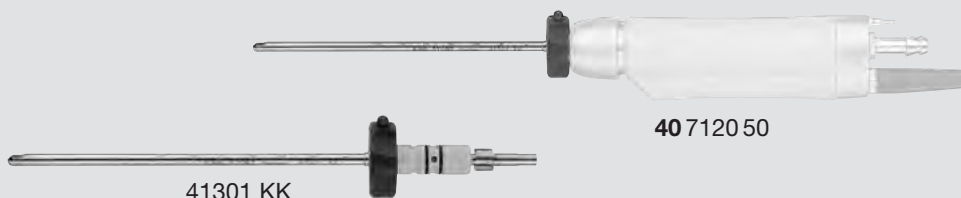

Detail	Shaver Blade, straight, length 12 cm, sterile, for single use, package of 5	
	41301 KN	serrated cutting edge, diameter 4 mm, color code: blue-red
	41301 KK	double serrated cutting edge, diameter 4 mm, color code: blue-yellow
	41301 GN	concave cutting edge, oval cutting window, diameter 4 mm, color code: blue-green
	41301 LN	concave cutting edge, oblique cutting window, diameter 4 mm, color code: blue-black
	41301 SN	straight cutting edge, diameter 4 mm, color code: blue-blue
	41301 KSA	serrated cutting edge, diameter 3 mm, color code: blue-red
	41301 KKSA	double serrated cutting edge, diameter 3 mm, color code: blue-yellow
	41301 KKSB	double serrated cutting edge, diameter 2 mm, color code: blue-yellow
	41301 LSA	concave cutting edge, oblique cutting window, diameter 3 mm, color code: blue-black

Shaver Blades

for surgery of the paranasal sinuses and anterior skull base



For use with DRILLCUT-X® II Shaver Handpiece 40 7120 50 and
DRILLCUT-X® II N Shaver Handpiece 40 7120 55



Detail	Shaver Blade, curved 35°/40°, length 12 cm, sterile, for single use, package of 5	
	41302 KN	curved 35°, cutting edge serrated backwards, single serrated, diameter 4 mm, color code: blue-red
	41304 KKF	curved 40°, cutting edge serrated forwards, double serrated, diameter 4 mm, color code: blue-yellow
	41304 KKB	curved 40°, cutting edge serrated backwards, double serrated, diameter 4 mm, color code: blue-yellow
	41304 KKFA	curved 40°, cutting edge serrated forwards, double serrated, diameter 3 mm, color code: blue-yellow
	41304 KKBA	curved 40°, cutting edge serrated backwards, double serrated, diameter 3 mm, color code: blue-yellow

Shaver Blades

for surgery of the paranasal sinuses and anterior skull base



For use with DRILLCUT-X® II Shaver Handpiece 40 7120 50 and
DRILLCUT-X® II N Shaver Handpiece 40 7120 55

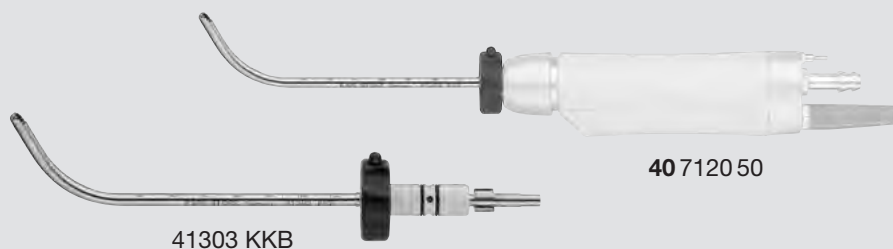

Detail	Shaver Blade, curved 65°, length 12 cm, sterile, for single use, package of 5	
	41303 KNF	curved 65°, cutting edge serrated forwards, single serrated, diameter 4 mm, color code: blue-red
	41303 KNB	curved 65°, cutting edge serrated backwards, single serrated, diameter 4 mm, color code: blue-red
	41303 KKF	curved 65°, cutting edge serrated forwards, double serrated, diameter 4 mm, color code: blue-yellow
	41303 KKB	curved 65°, cutting edge serrated backwards, double serrated, diameter 4 mm, color code: blue-yellow
	41303 KKFA	curved 65°, cutting edge serrated forwards, double serrated, diameter 3 mm, color code: blue-yellow
	41303 KKBA	curved 65°, cutting edge serrated backwards, double serrated, diameter 3 mm, color code: blue-yellow

Sinus Burrs

for surgery of the paranasal sinuses and anterior skull base



For use with DRILLCUT-X® II Shaver Handpiece 40 7120 50 and
DRILLCUT-X® II N Shaver Handpiece 40 7120 55

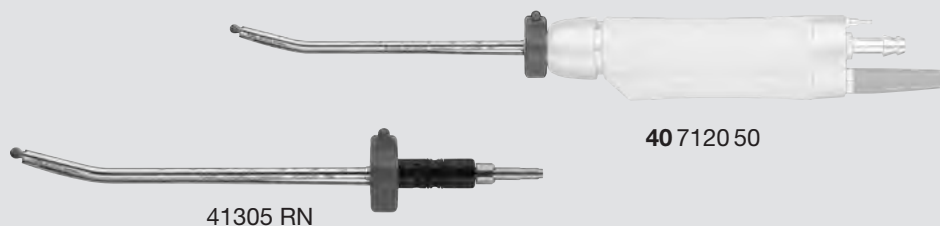

Detail	Sinus Burr, curved 70°/55°/40°/15°, length 12 cm, sterile, for single use, package of 5	
	41304 W	curved 40°, cylindrical, drill diameter 3 mm, shaft diameter 4 mm, color code: red-blue
	41303 WN	curved 55°, cylindrical, drill diameter 3.6 mm, shaft diameter 4 mm, color code: red-blue
	41305 RN	curved 15°, bud drill, drill diameter 4 mm, shaft diameter 4 mm, color code: red-black
	41305 DN	curved 15°, diamond head, drill diameter 3 mm, shaft diameter 4 mm, color code: red-yellow
	41305 D*	curved 15°, diamond head, drill diameter 5 mm, shaft diameter 4 mm, color code: red-yellow
	41305 DW*	curved 40°, diamond head, drill diameter 5 mm, shaft diameter 4 mm, color code: red-yellow
	41303 DT*	curved 70°, diamond head, drill diameter 3.6 mm, shaft diameter 4 mm, color code: red-yellow

* The above instruments are navigated sinus burrs. For further information on optical and electromagnetic navigation see chapter 16 NAVIGATION

Sinus Burrs 35 k

for surgery of the paranasal sinuses and anterior skull base



For use with DRILLCUT-X® II-35 Shaver Handpiece 40 7120 35 and
DRILLCUT-X® II-35 N Shaver Handpiece 40 7125 35

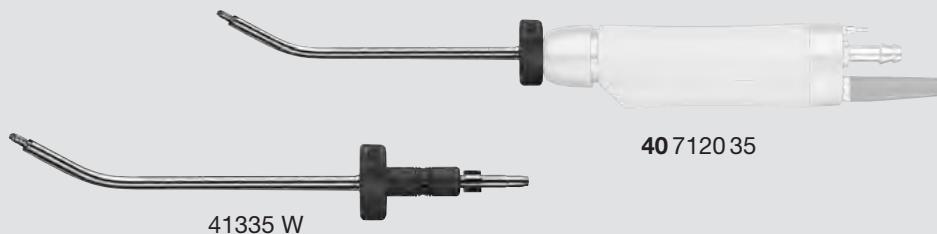

Detail	Sinus Burr 35 k, curved 70°/40°/15°, length 12 cm, sterile, for single use, package of 5	
	41335 W	curved 40°, cylindrical, drill diameter 3 mm, shaft diameter 4 mm, color code: red
	41335 RN	curved 15°, bud drill, drill diameter 4 mm, shaft diameter 4 mm, color code: red
	41335 DW*	curved 40°, diamond head, drill diameter 5 mm, shaft diameter 4 mm, color code: red
	41335 DT*	curved 70°, diamond head, drill diameter 3.6 mm, shaft diameter 4 mm, color code: red
	41335 DS	curved 40°, diamond head, drill diameter 4 mm, shaft diameter 4 mm, color code: red

* The above instruments are navigated sinus burrs. For further information on optical and electromagnetic navigation see chapter 16 NAVIGATION

Shaver Blades

for Endolaryngeal Microsurgery



STERILE

For use with DRILLCUT-X® II Shaver Handpiece 40 7120 50 and
DRILLCUT-X® II N Shaver Handpiece 40 7120 55

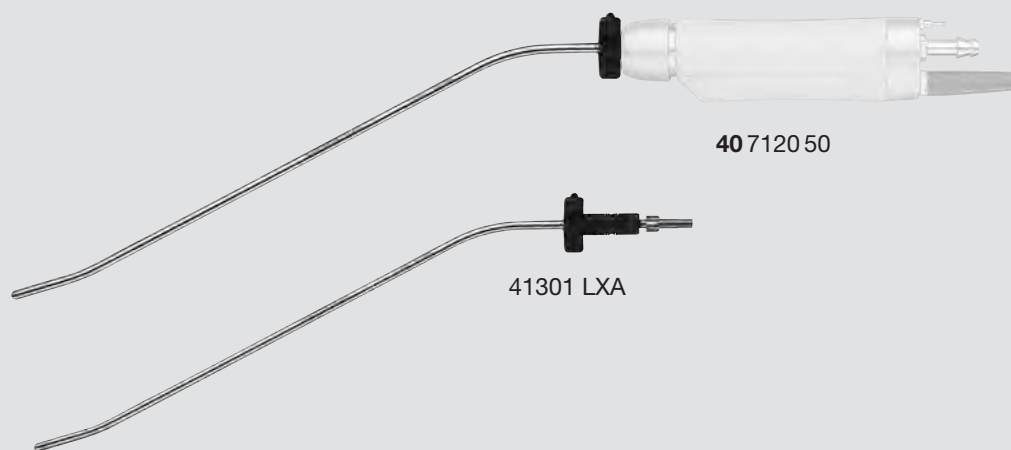

41301 LXA

Larynx Shaver Attachment, with integrated irrigation, distally curved 18°, proximally curved 30°, oval cutting edge, oval cutting window, diameter 3 mm, length 27 cm, sterile, for single use, package of 5, for use with DRILLCUT-X® II Handpieces 40 7120 50 and 40 7120 55, color code: blue-green

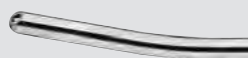

41301 LX

Larynx Shaver Attachment, with integrated irrigation, distally curved 18°, proximally curved 30°, oval cutting edge, oval cutting window, diameter 4 mm, length 27 cm, sterile, for single use, package of 5, for use with DRILLCUT-X® II Handpieces 40 7120 50 and 40 7120 55, color code: blue-green

Probes

Lachrymal Probe



Probe for Diaphanoscopic Localization of the Nasolacrimal Ducts



Dacryocystorhinostomy acc. to SIEGERT/WEERDA

The obstructed nasolacrimal ducts have to be represented intraoperatively for dacryocystorhinostomy. However, intraoperative endonasal localization of the pathologically changed ducts may prove difficult, due to the considerable anatomical variations from one patient to the next. The instruments for representation of the nasolacrimal duct comprise a light source, a light guide and a special lachrymal probe with a distal diameter of 0.5 mm.

For endonasal dacryocystorhinostomy, the sterile distal end of the lachrymal probe is introduced into the lacrimal sac, or up to the point of the blockage, through the upper or lower lacrimal point. The spot of light

visible at the end of the light guide “marks” the nasal end of the clear lacrimal duct. It is advisable to briefly turn down the external lights in the operating room at first in order to locate the nasolacrimal duct while the lacrimal sac is still covered by considerable tissue.

A study on such operations has shown that the times required for surgery can be significantly reduced by around 50% with the aid of diaphanoscopic localization.

On the whole, this is a simple, practical and useful complementary imaging for dacryocystorhinostomy which supports rapid surgery without undue damage to the tissue.

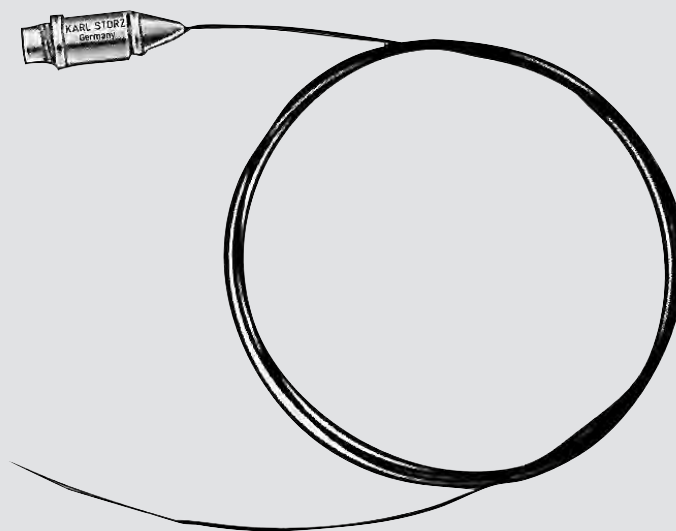

496 V

496 V

Lachrymal Probe, for diaphanoscopic localization of the nasolacrimal ducts and fistulae, diameter of distal tip 0.5 mm, sterile, for single use, package of 3, for use with Fiber Optic Light Cable 495 NL

Injection

Cannulas, Syringe



For use with High Pressure Syringe 771400

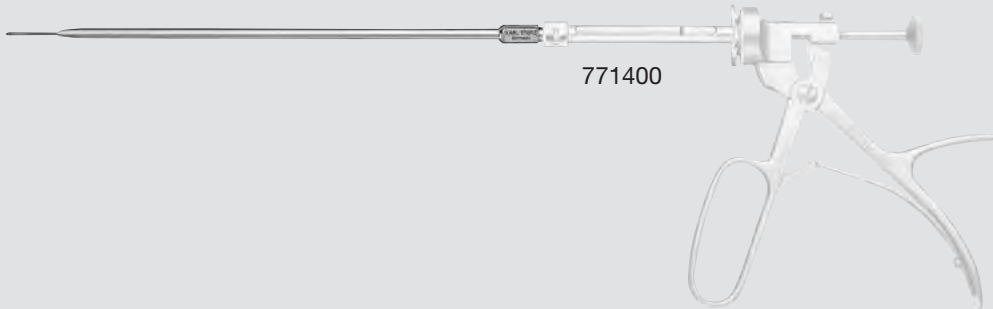

771400



27200 S



27200 SK

Injection Cannula, short tip, LUER-Lock, tip outer diameter 1 mm, inner diameter 0.7 mm, working length 18 cm, for single use, package of 3



27200 SL

Injection Cannula, LUER-Lock, tip outer diameter 1.3 mm, inner diameter 1.1 mm, working length 18 cm, for single use, package of 3



27200 SM

Injection Cannula, LUER-Lock, tip outer diameter 1.3 mm, inner diameter 1.1 mm, working length 15 cm, for single use, package of 3

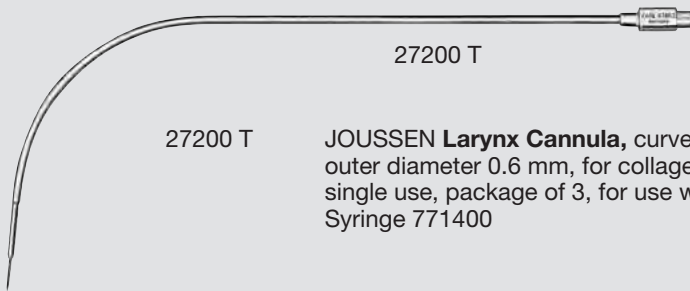

27200 T

27200 T

JOUSSEN Larynx Cannula, curved, LUER-Lock, tip outer diameter 0.6 mm, for collagen application, for single use, package of 3, for use with High Pressure Syringe 771400

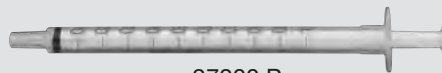

27200 P

27200 P

Plastic Syringe, 1 ml, for single use, package of 100

Injection

Syringe



For use with PERETTI High Pressure Syringe 771410

STERILE 

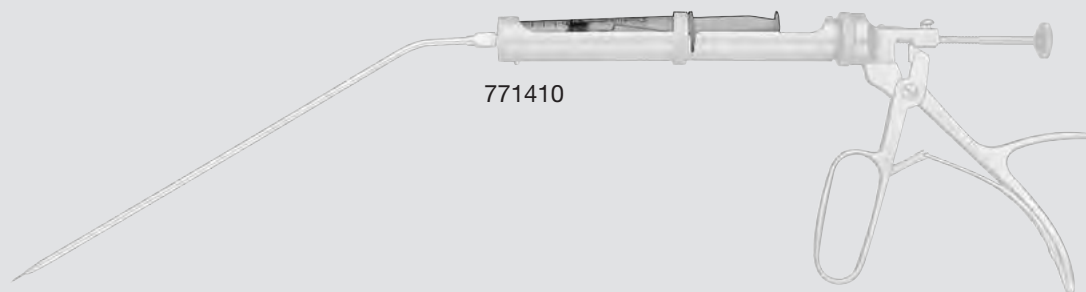

771410



771415

771415

Plastic Syringe, spring-action, self-retaining, 10 ml, sterile, for single use, package of 25

Tubing Sets

Irrigation Tubing Sets



Special Features:

- No risk of confusion when placing the connectors
- Automatic product recognition and mode selection via the pump

For use with ENDOMAT® SELECT



031529-10

031529-10 **Tubing Set for Irrigation, CV, sterile, for single use, package of 10, for use with ENDOMAT® SELECT**

Tubing Sets

Irrigation Tubing Sets



For use with CLEARVISION®, UNIDRIVE® II plus, UNIDRIVE® ENT/ECO/NEURO, UNIDRIVE® S III ENT/ECO/NEURO and/or CLEARVISION® II

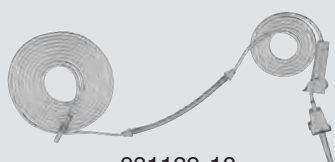

031129-10

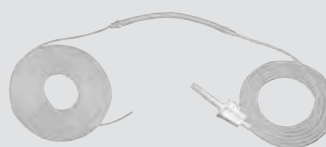

031130-10



031131-10



031229-10

- 031129-10 **Tubing Set**, sterile, for single use, package of 10, for use with CLEARVISION®
- 031130-10 **Tubing Set**, sterile, for single use, package of 10, for use with UNIDRIVE® II plus
- 031131-10 **Tubing Set**, sterile, for single use, package of 10, for use with UNIDRIVE® ENT/ECO/NEURO, UNIDRIVE® S III ENT/ECO/NEURO
- 031229-10 **Tubing Set**, sterile, for single use, package of 10, for use with CLEARVISION® II

Spare Parts and Accessories

Push-Button Pressure Valve



For use with THUMFART Handle 723620 H and IRO Handle 723622 H



723620 H



101010-10 **Push-Button Pressure Valve**, sterile,
for single use, package of 10

Spare Parts and Accessories

Replacement Blades for Dermatomes

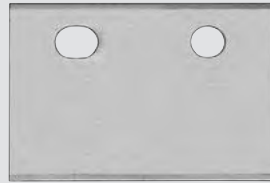

253101

- 253001 **Replacement Blade**, width of incision 12 mm, sterile, for single use, package of 10, for use with Dermatome 253000
- 253101 **Replacement Blade**, width of incision 25 mm, sterile, for single use, package of 10, for use with Dermatome 253100
- 253201 **Replacement Blade**, width of incision 50 mm, sterile, for single use, package of 10, for use with Dermatome 253200
- 253301 **Replacement Blade**, width of incision 75 mm, sterile, for single use, package of 10, for use with Dermatome 253300

Spare Parts and Accessories

Ear Specula



For use with CMOS Video Otoscope 121200 and
USB Video Otoscope 121210



121200



121204

Ear Speculum, for CMOS video otoscope and
USB video otoscope, outer diameter 4 mm, black,
unsterile, for single use, package of 1000

121204 S

Same, package of 100

For use with HEINE Otoscope 121300, with Battery Handle 121300 and
HEINE Otoscope 121320



121300



121332

Ear Speculum, gray, outer diameter 2.5 mm, for
children, unsterile, for single use, package of 1000

121334

Same, outer diameter 4 mm, for adults

Spare Parts and Accessories

Blades



For use with Surgical Handle, Fig. 3, 208000 and 208001



208000



208010

Blade, Fig. 10, unsterile, for single use, package of 100



208011

Same, Fig. 11



208015

Same, Fig. 15



208210

Blade, Fig. 10, sterile, for single use, package of 100



208211

Same, Fig. 11



208215

Same, Fig. 15

Spare Parts and Accessories

Blades



For use with Surgical Handle 496550



496550



496764

Miniature Blade, Fig. 64, round, sterile,
for single use, package of 25



496765

Same, Fig. 65, pointed

Spare Parts and Accessories

Epistaxis Balloon Catheter, Ventilation Tubes

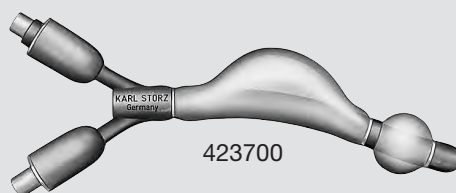

423700 REUTER **Epistaxis Balloon Catheter**, sterile, for single use



230100 **TÜBINGEN Ventilation Tube**, made of precious metal and gold-plated, without retrieval wire, inner diameter 1.5 mm, size 2, outer diameter 2.8 mm, sterile, for single use, package of 10



230110 **TÜBINGEN Ventilation Tube**, made of precious metal and gold-plated, without retrieval wire, inner diameter 1.25 mm, size 1, outer diameter 2.6 mm, sterile, for single use, package of 10

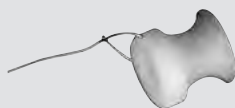

230506 **SHEPARD Ventilation Tube**, Teflon, with retrieval wire, inner diameter 1.1 mm, sterile, for single use, package of 6

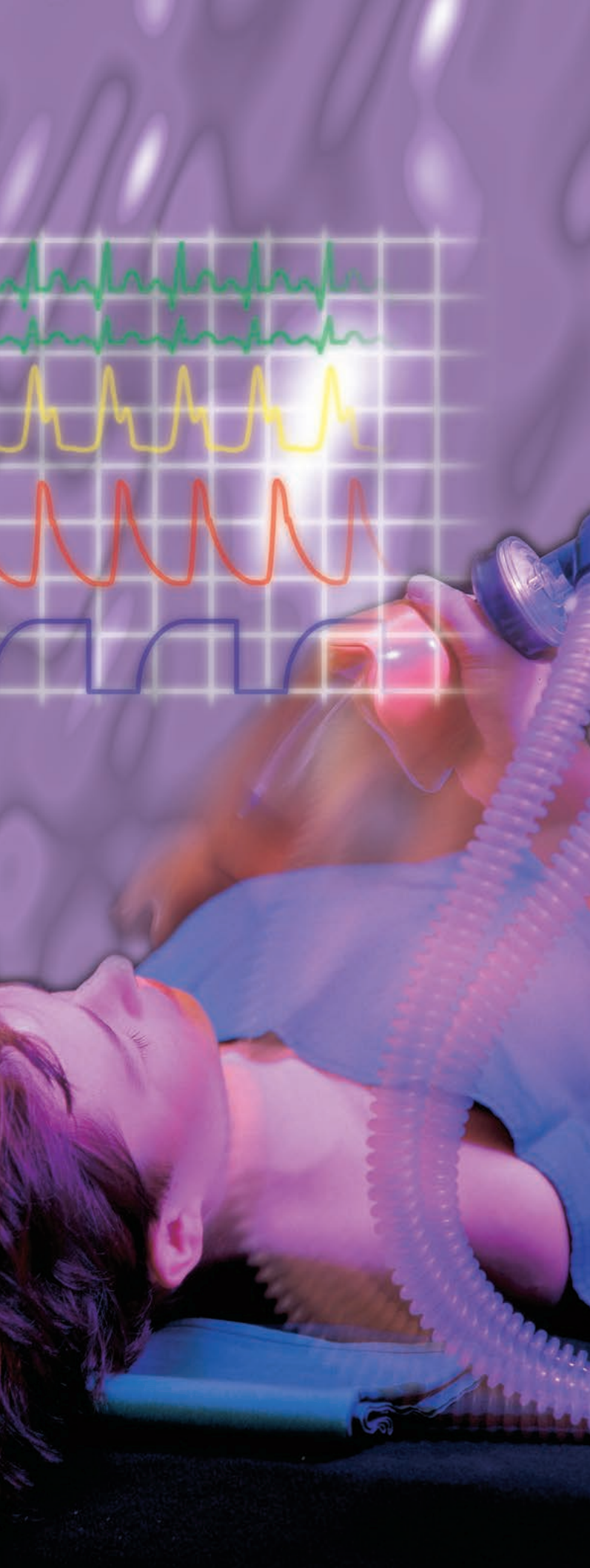

ANESTHESIOLOGY AND EMERGENCY MEDICINE

C-MAC® S VIDEO LARYNGOSCOPES . . . 51-53

LARYNGOBLOC
COLD LIGHT LARYNGOSCOPES 54-56

INTUBATION ENDOSCOPES,
ACCESSORIES 57-58

MACINTOSH C-MAC® S Video Laryngoscopes

The C-MAC® System



Special Features:

- Blade and handle with anti-dirt layer form one continuous piece: Optimal protection against cross-contamination
- Extremely robust
- Ergonomic handle shape
- Compact design
- For direct and indirect laryngoscopy with the original MACINTOSH blade shape
- For routine clinical use and training
- D-BLADE for difficult intubation with short handle

For use with C-MAC® S IMAGER 8403 XSI in combination with C-MAC® PM 8403 XDK or C-MAC® Monitor 8403 ZXK with 8403 X or 20 2903 01 C-HUB® II

ready to
use



8403 XSI



051114-10

C-MAC® S Video Laryngoscope MAC #4, with MACINTOSH laryngoscope blade, size 4, for single use, package of 10, for use with KARL STORZ C-MAC® S IMAGER 8402 XS, 8403 XS or 8403 XSI



051113-10

C-MAC® S Video Laryngoscope MAC #3, with MACINTOSH laryngoscope blade, size 3, for single use, package of 10, for use with KARL STORZ C-MAC® S IMAGER 8402 XS, 8403 XS or 8403 XSI

C-MAC® S Video Laryngoscope D-BLADE

The C-MAC® System



ready to
use



For use with C-MAC® S IMAGER 8403 XSI in combination with
C-MAC® PM 8403 XDK or C-MAC® Monitor 8403 ZXK with 8403 X or
20 2903 01 C-HUB® II



8403 XSI



051116-10

C-MAC® S Video Laryngoscope D-BLADE,
with laryngoscope blade for difficult intubation,
for single use, package of 10, for use with
KARL STORZ C-MAC® S IMAGER 8402 XS,
8403 XS or 8403 XSI

MILLER C-MAC® S Video Laryngoscopes

The C-MAC® System



Special Features:

- Blade and handle with anti-dirt layer form one continuous piece: Optimal protection against cross-contamination
- Extremely robust
- Ergonomic handle shape
- Compact design
- For direct and indirect laryngoscopy with the original MILLER blade shape
- For routine clinical use and training

For use with C-MAC® S Pediatric IMAGER 8403 XSP in combination with C-MAC® PM 8403 XDK or C-MAC® Monitor 8403 ZXK with 8403 X

ready to use



051111-10 **C-MAC® S Video Laryngoscope MILLER #1**, for single use, package of 10, for use with C-MAC® S Pediatric IMAGER 8403 XSP



051110-10 **C-MAC® S Video Laryngoscope MILLER #0**, for single use, package of 10, for use with C-MAC® S Pediatric IMAGER 8403 XSP

MACINTOSH Laryngobloc

Cold Light Laryngoscopes



Special Features:

- Handle and blade in monoblock design
- High tensile strength
- Optimal hygiene
- Various handles: Standard, slender and stubby
- Various blade shapes: MACINTOSH, MILLER and OXFORD model
- LED with service life of 50,000 hours
- Latex-free polypropylene (PP)

ready to use



For use with LED Battery Insert 8547 HL



8547 HL



8512 AF

- 8512 AF MACINTOSH **Laryngobloc**, size 4, material: polypropylene, handle and blade in one piece, standard handle, clean packed, for single use, package of 20, for use with LED Battery Insert 8547 HL
- 8512 BF **Same**, size 3
- 8512 C **Same**, size 2

For use with LED Battery Insert 8547 HS



8547 HS



8512 CS

- 8512 ASF MACINTOSH **Laryngobloc**, size 4, material: polypropylene, handle and blade in one piece, short handle, clean packed, for single use, package of 20, for use with LED Battery Insert 8547 HS
- 8512 BSF **Same**, size 3
- 8512 CS **Same**, size 2

MILLER Laryngobloc

Cold Light Laryngoscopes



For use with LED Battery Insert 8547 HL

ready to use



8547 HL



8530 B

8530 B

MILLER **Laryngobloc**, size 3, material: polypropylene, handle and blade in one piece, standard handle, for single use, package of 20, for use with LED Battery Insert 8547 HL

8530 C

Same, size 2

For use with LED Battery Insert 8547 HN



8547 HN



8530 DN

8530 DN

MILLER **Laryngobloc**, size 1, material: polypropylene, handle and blade in one piece, slender handle, clean packed, for single use, package of 20, for use with LED Battery Insert 8547 HN

8530 EN

Size, size 0

Laryngobloc, OXFORD Model

Cold Light Laryngoscopes



ready to use



For use with LED Battery Insert 8547 HL



8547 HL



8533 F

8533 F

Laryngobloc, OXFORD model, size 0, material: polypropylene, handle and blade in one piece, standard handle, for single use, package of 20, for use with LED Battery Insert 8547 HL

For use with LED Battery Insert 8547 HS



8547 HS



8533 FS

8533 FS

Laryngobloc, OXFORD model, size 0, material: polypropylene, handle and blade in one piece, short handle, for single use, package of 20, for use with LED Battery Insert 8547 HS

Intubation Endoscopes, Accessories

Flexible Intubation Video Endoscopes (FIVE) and Eyepiece Versions



For use with Flexible Intubation Fiberscopes 11301 BN1, 11302 BD2 and 11301 AA1



11301 BN1



11301 CE

Suction Valve, for single use,
package of 20

For use with Flexible Intubation Video Endoscopes 11301 BNX and 11302 BDX



11301 BNX



11301 CE1

Suction Valve, for single use,
package of 20



For use with Flexible Intubation Endoscopes

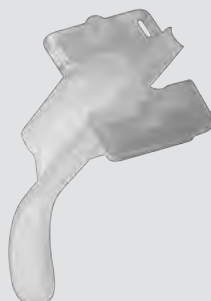

10309
10310

- 10309 **Bronchoscope Insertion Tube**, size 4, with integrated mouthpiece, insertion length 85 mm, made from EVA, sterile, for single use, package of 10, for use with intubation fiberscopes
- 10310 **Bronchoscope Insertion Tube**, size 2, with integrated mouthpiece, insertion length 65 mm, made from EVA, sterile, for single use, package of 10, for use with flexible intubation endoscopes



11008 C

- 11008 C **Mask Adaption "MAINZ Adaptor"**, for endoscopic inspection and simultaneous respiration, blue, sterile, package of 5



THORAX

CAMERA COVER 60

BIOPSY FORCEPS 61

TUBING SET 62

SPARE PARTS AND
ACCESSORIES 63

Cover

Camera Cover



For use with IMAGE1 S™ DCI® camera head for Distending Video Mediastinoscopes 10972 SP and 10972 SPS as well as DCI® Video Mediastinoscopes 10971 MV and 10971 MVS



041171-40

041171-40 **Camera Cover**, width at camera head 6 cm, length 309 cm, sterile, for single use, package of 40

Biopsy Forceps



Special Features:

- Optimized tissue removal through fenestrated cups
- Hygienic and functional safety

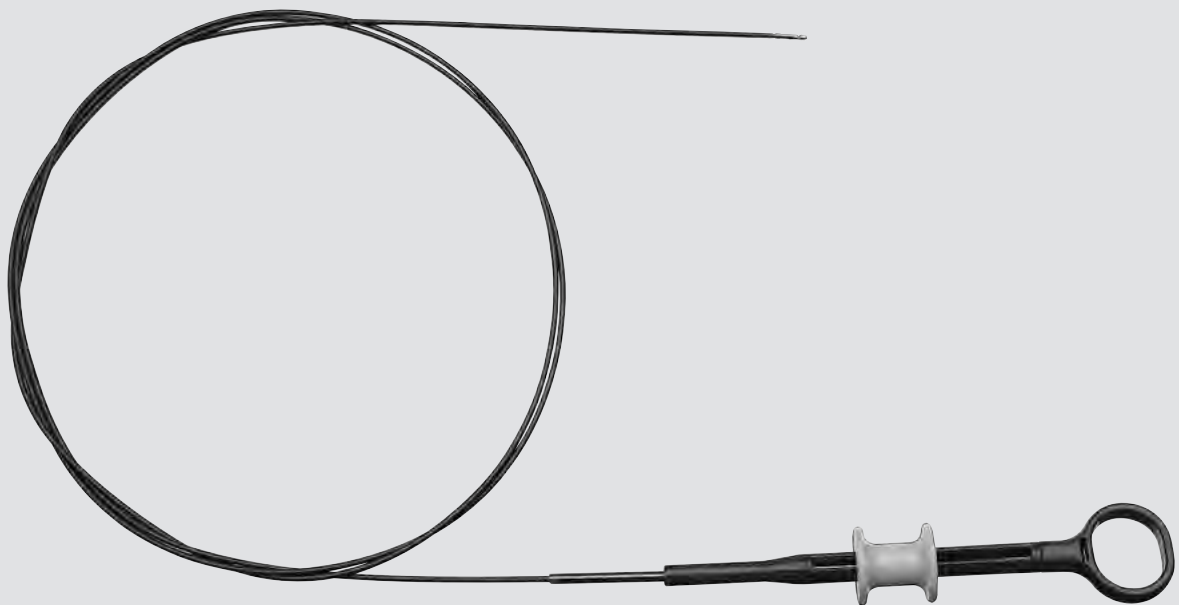

110274-10



110274-10

Biopsy Forceps, with oval jaws, working length 120 cm, sterile, for single use, package of 10, for use with flexible endoscopes with working channels as of diameter 2 mm

Tubing Set

Irrigation Tubing Set



Special Features:

- No risk of confusion when placing the connectors
- Automatic product recognition and mode selection via the pump

For use with ENDOMAT® SELECT



031524-10

031524-10 **Tubing Set for Irrigation, FC, sterile, for single use, package of 10, for use with HAMOU® ENDOMAT® SCB 26 3311 20-1 and ENDOMAT® SELECT**

Spare Parts and Accessories

Leaflet Valve and Suction Valve for Flexible Bronchoscopy



For use with Broncho-Fiberscopes 11004 BC, 11009 BC, 11001 BN, 11002 BD and 11003 BC as well as Autofluorescence Broncho-Fiberscopes 11004 BI, 11009 BI and 11001 BI

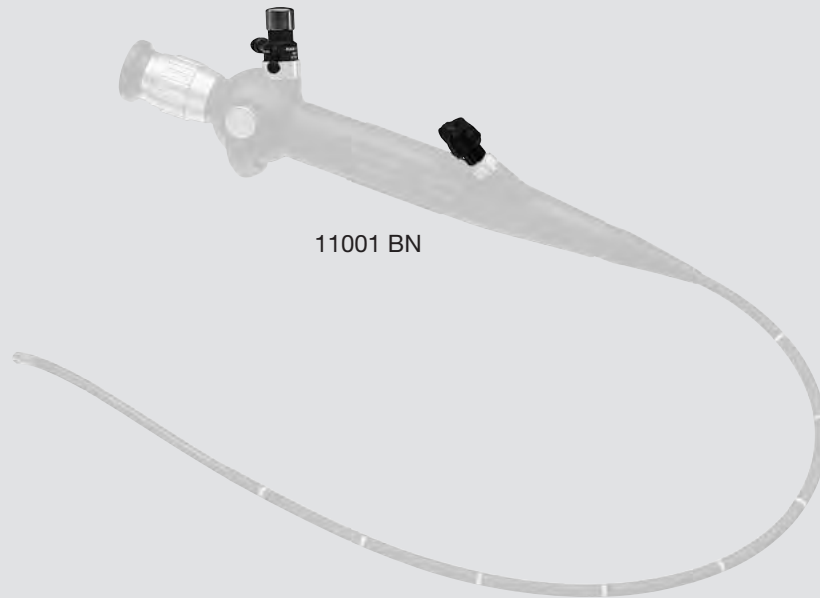

11001 BN



11301 CA **Leaflet Valve**, unsterile, for single use, package of 20

11301 CE **Suction Valve**, unsterile, for single use, package of 20

SYSTEMS FOR GASTROENTEROLOGY

ALBARRAN MODULE 66

BIOPSY FORCEPS 67

GRASPING FORCEPS 68-69

POLYPECTOMY SNARES,
PAPILLOTOMES 70-72

INJECTION NEEDLES,
CYTOLOGY BRUSHES 73-74

ERCP AND
SPRAY CATHETERS 75

GUIDE WIRE, BITE PROTECTOR,
CLEANING BRUSHES 76-79





Special Features:

- For optimal hygiene results and maximum patient safety
- Ready for immediate use
- No reprocessing of the module required in the hospital
- Minimizes the risk of inadequate cleaning and disinfection

STERILE 

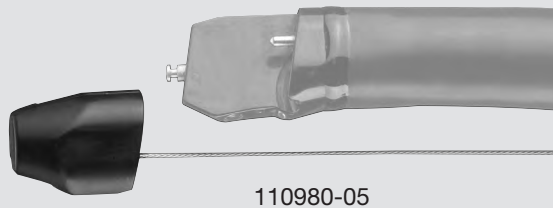

110980-05 **Albarran Module**, sterile, for single use, package of 5, for use with SILVER SCOPE® Duodenoscopes 13885 PKS/NKS

Biopsy Forceps



Special Features:

- Optimized tissue removal through fenestrated cups
- Forceps with spike for very good anchorage of tissue
- Hygienic and functional safety
- One-hand grip with rotating thumb ring with color-coded diameter (blue = 2 mm, yellow = 2.8 mm)

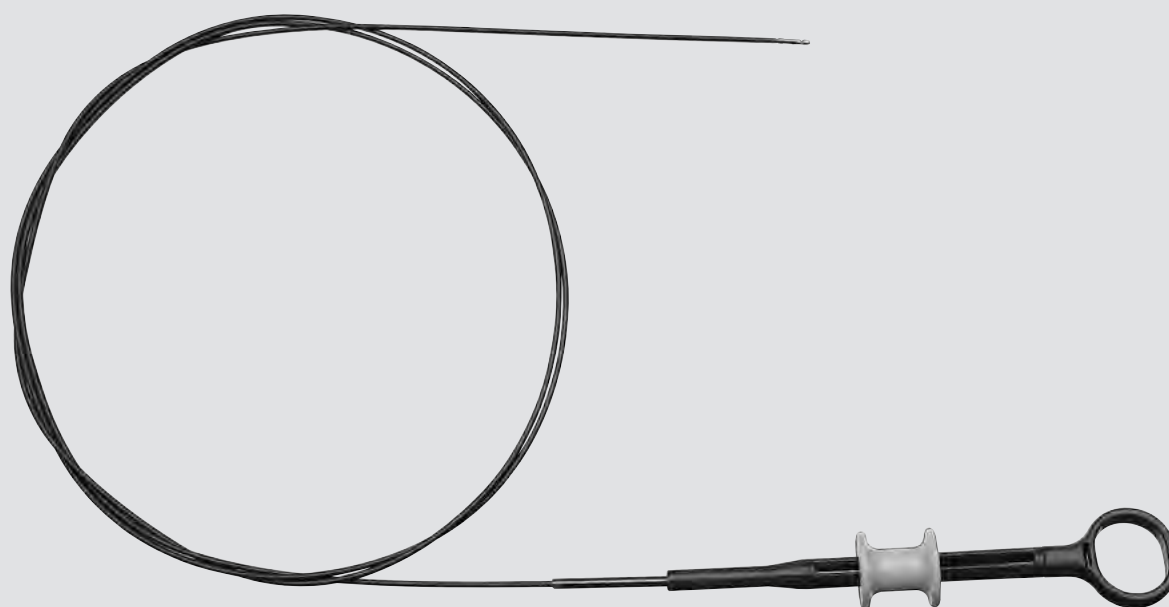

110282-10



110285-10 **Biopsy Forceps**, with oval jaws, coated, working length 160 cm, sterile, for single use, package of 10, for use with flexible endoscopes with working channels as of diameter 2 mm



110282-10 **Biopsy Forceps**, with oval jaws, coated, working length 180 cm, sterile, for single use, package of 10, for use with flexible endoscopes with working channels as of diameter 2.8 mm

110283-10 **Same**, working length 230 cm



110280-10 **Biopsy Forceps**, with oval jaws and spike, coated, working length 180 cm, sterile, for single use, package of 10, for use with flexible endoscopes with working channels as of diameter 2.8 mm

110281-10 **Same**, working length 230 cm



Special Features:

- The large opening angle of the pelican forceps makes it particularly suitable for grasping large objects
- The alligator forceps is suitable for grasping angular or sharp objects thanks to its alligator-like ribbed jaws

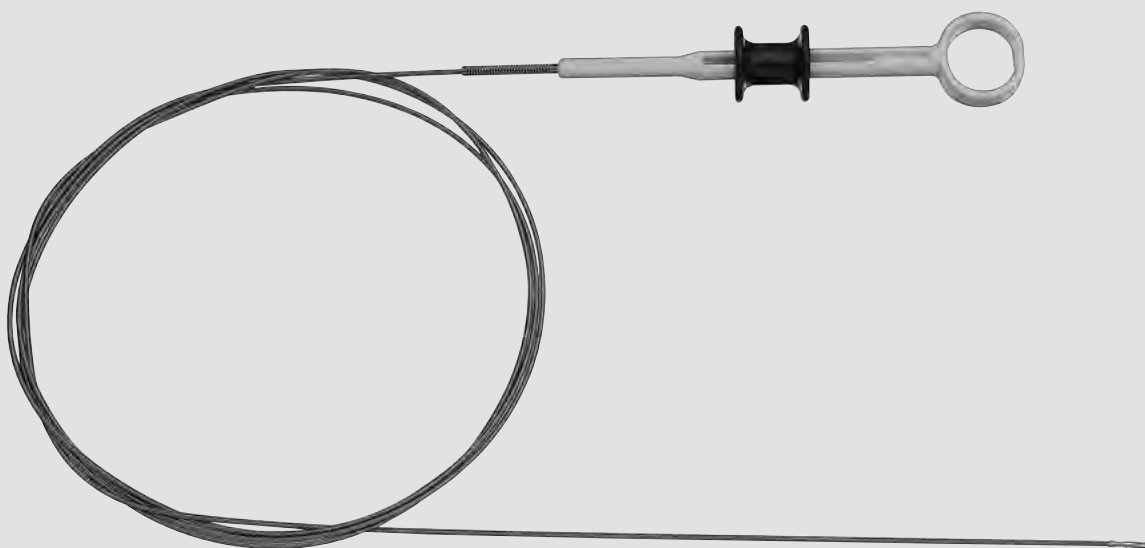

110350-10

Pelican Grasping Forceps



- 110343-10 **Grasping Forceps Type Pelican**, with large opening angle, diameter 2.4 mm, working length 170 cm, sterile, for single use, package of 10, for use with flexible endoscopes with working channels as of diameter 2.8 mm
- 110344-10 **Same**, working length 210 cm

Alligator Grasping Forceps



- 110350-10 **Grasping Forceps Type Alligator**, ribbed, diameter 1.8 mm, working length 100 cm, sterile, for single use, package of 10, for use with flexible endoscopes with working channels as of diameter 2 mm
- 110351-10 **Same**, working length 150 cm
- 110352-10 **Grasping Forceps Type Alligator**, ribbed, diameter 2.4 mm, working length 150 cm, sterile, for single use, package of 10, for use with flexible endoscopes with working channels as of diameter 2.8 mm
- 110353-10 **Same**, working length 170 cm
- 110354-10 **Same**, working length 210 cm



Special Features:

- The rat tooth forceps is particularly suitable for grasping flat and solid objects
- The rat tooth forceps with alligator jaws is especially suitable for retrieving difficult-to-extract flat and solid objects

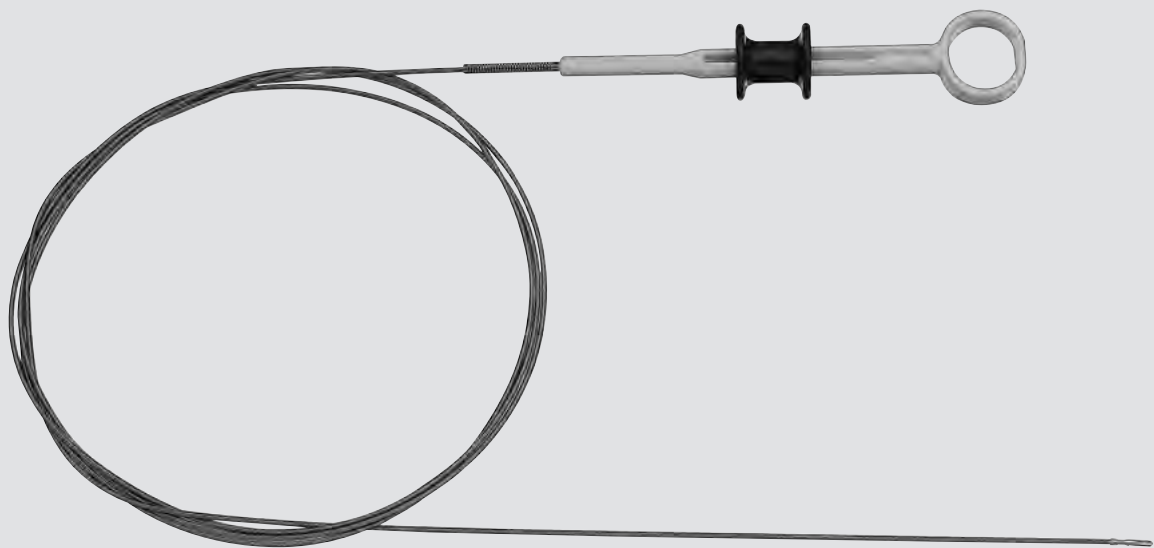

110371-10

Rat Tooth Grasping Forceps



- 110363-10 **Grasping Forceps Type Rat Tooth**, diameter 2.4 mm, working length 170 cm, sterile, for single use, package of 10, for use with flexible endoscopes with working channels as of diameter 2.8 mm
- 110364-10 **Same**, working length 210 cm

Rat Tooth Grasping Forceps with Alligator Jaws



- 110371-10 **Grasping Forceps Type Rat Tooth with Alligator Jaws**, diameter 1.8 mm, working length 150 cm, sterile, for single use, package of 10, for use with flexible endoscopes with working channels as of diameter 2 mm
- 110372-10 **Rat Tooth Grasping Forceps with Alligator Jaws**, diameter 2.4 mm, working length 150 cm, sterile, for single use, package of 10, for use with flexible endoscopes with working channels as of diameter 2.8 mm



Special Features:

- **Smooth, flexible snare cord makes even cutting and coagulation possible**
- **Very safe thanks to soldered connection between traction component and snare**

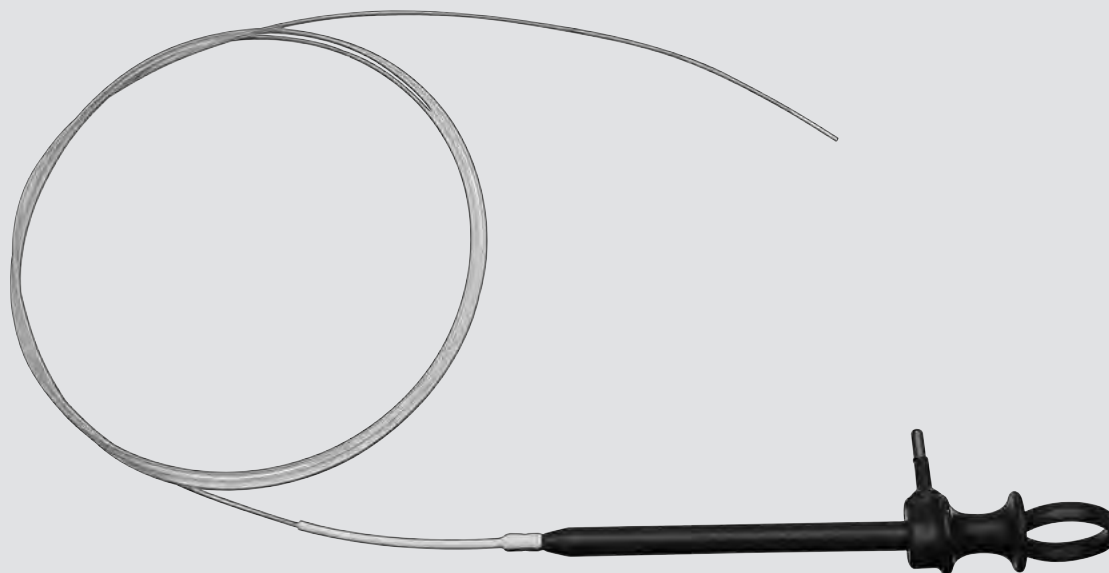

110282-10

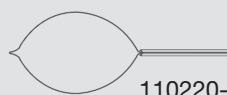

110220-10

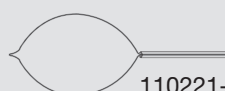

110221-10

110220-10 **Oval Polypectomy Snare**, diameter 30 mm, working length 180 cm, KARL STORZ HF connector, sterile, for single use, package of 10, for use with flexible endoscopes with working channels as of diameter 2 mm

110221-10 **Oval Polypectomy Snare**, diameter 30 mm, working length 230 cm, KARL STORZ HF connector, sterile, for single use, package of 10, for use with flexible endoscopes with working channels as of diameter 2.8 mm



110222-10

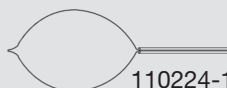

110224-10

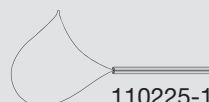

110225-10

110222-10 **Oval Polypectomy Snare**, diameter 20 mm, working length 230 cm, standard HF connector, sterile, for single use, package of 10, for use with flexible endoscopes with working channels as of diameter 2.8 mm

110224-10 **Same**, diameter 30 mm

110225-10 **Asymmetric Polypectomy Snare**, diameter 25 mm, working length 230 cm, standard HF connector, sterile, for single use, package of 10, for use with flexible endoscopes with working channels as of diameter 2.8 mm

Papillotomes



Special Features:

- Simplified positioning thanks to pre-formed tip
- Suitable for guide wire (double lumen)
- X-ray resistant tip

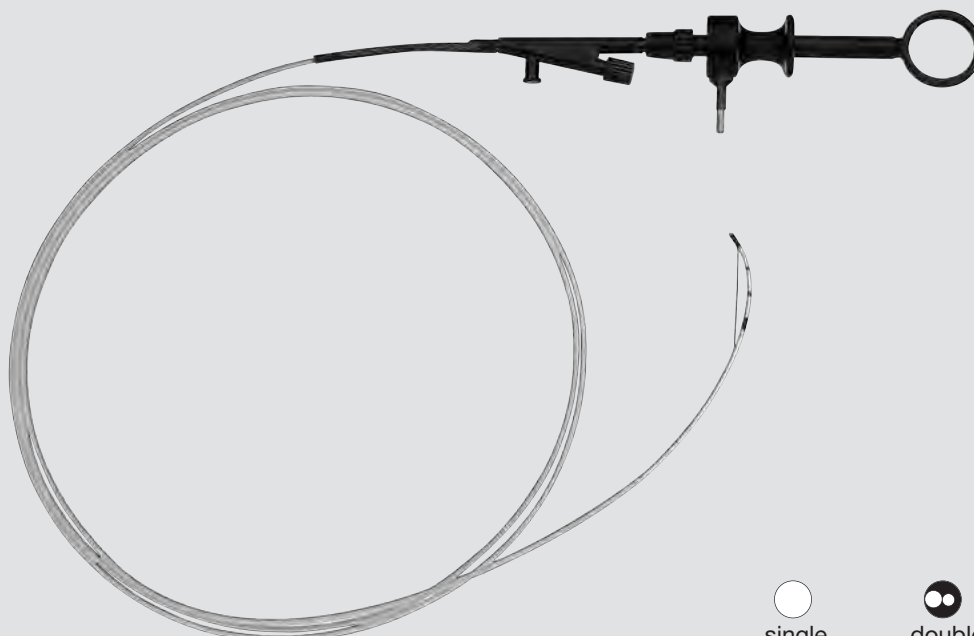

110210-05



single lumen



double lumen



110210-05

Papillotome, filiform, single lumen, cutting wire length 25 mm, including handle, working length 200 cm, KARL STORZ HF connector, sterile, for single use, package of 5, for use with flexible endoscopes with working channels as of diameter 2.2 mm



110211-05

Papillotome, filiform, double lumen, cutting wire length 25 mm, for guide wire 0.035", including handle, working length 200 cm, KARL STORZ HF connector, sterile, for single use, package of 5, for use with flexible endoscopes with working channels as of diameter 2.8 mm

Papillotomes



Special Features:

- Simplified positioning thanks to pre-formed tip
- Suitable for guide wire (double and triple lumen)
- X-ray resistant tip

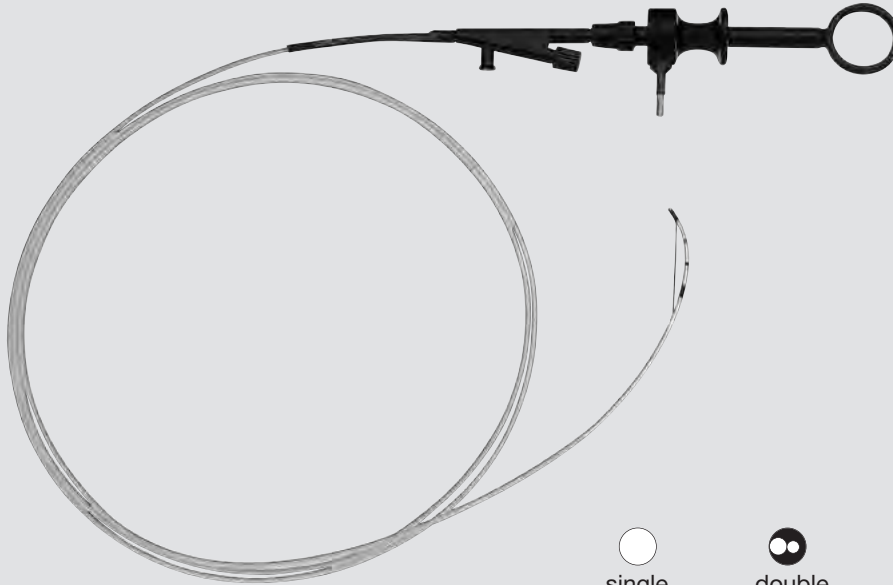

110213-05



110213-05

Papillotome, filiform, single lumen, cutting wire length 25 mm, including handle, working length 200 cm, standard HF connector, sterile, for single use, package of 5, for use with flexible endoscopes with working channels as of diameter 2.2 mm



110214-05

Papillotome, filiform, double lumen, cutting wire length 20 mm, for guide wire 0.035", including handle, working length 200 cm, standard HF connector, sterile, for single use, package of 5, for use with flexible endoscopes with working channels as of diameter 2.8 mm

110215-05

Same, cutting wire length 25 mm

110216-05

Same, cutting wire length 30 mm

110217-05

Papillotome, filiform, triple lumen, cutting wire length 20 mm, for guide wire 0.035", including handle, working length 200 cm, standard HF connector, sterile, for single use, package of 5, for use with flexible endoscopes with working channels as of diameter 2.8 mm

110218-05

Same, cutting wire length 25 mm

110219-05

Same, cutting wire length 30 mm

Injection Needles



Special Features:

- Protects against biopsy channel perforation (retaining ring)
- Locking screw for constant needle length
- Also suitable for thin mucous membrane tissue due to 21° special cut

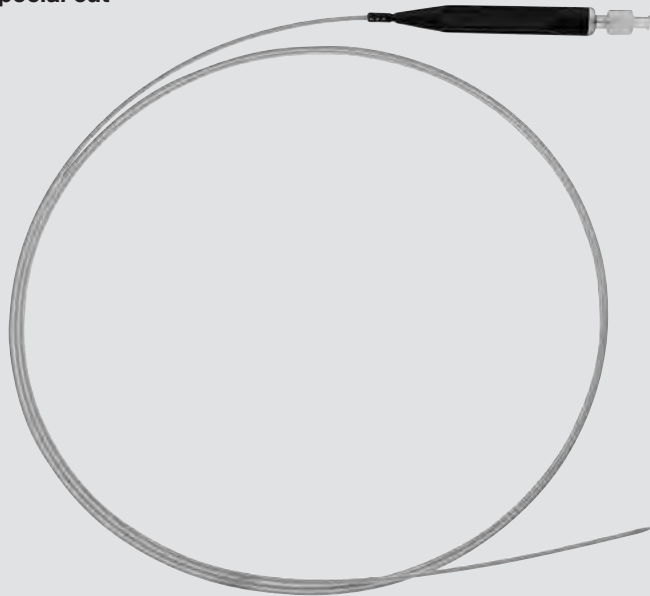

110230-10

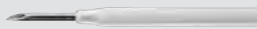

110230-10 **Injection Needle**, in plastic tube, needle diameter 0.7 mm, needle length 6 mm, working length 180 cm, sterile, for single use, package of 10, for use with flexible endoscopes with working channels as of diameter 2.6 mm

110231-10 **Same**, working length 230 cm



110232-10 **Injection Needle**, in plastic tube, needle diameter 0.9 mm, needle length 6 mm, working length 180 cm, sterile, for single use, package of 10, for use with flexible endoscopes with working channels as of diameter 2.6 mm

110233-10 **Same**, working length 230 cm



Special Features:

- Spherical head for sealing off the tube (prevents contamination)

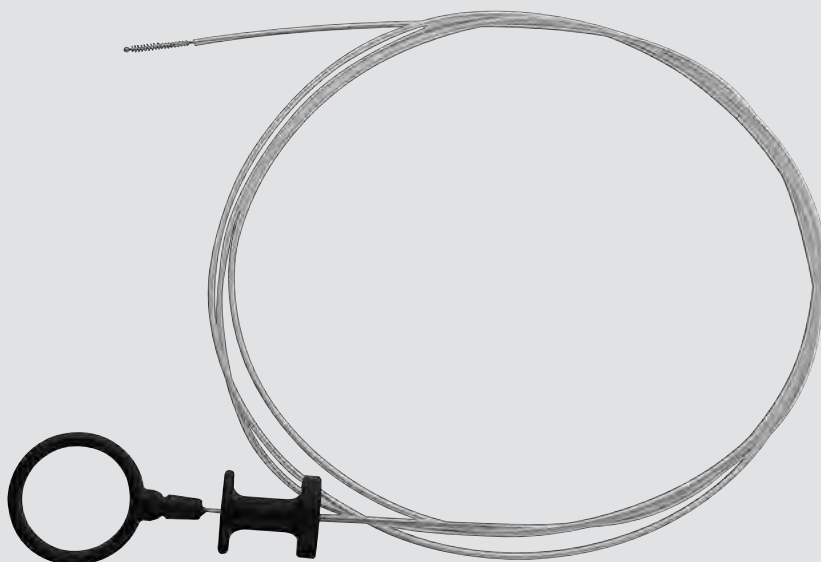

110240-10



110240-10

Cytology Brush, working length 180 cm, sterile, for single use, package of 10, for use with flexible endoscopes with working channels as of diameter 2 mm



110241-10

Cytology Brush, working length 230 cm, sterile, for single use, package of 10, for use with flexible endoscopes with working channels as of diameter 2.8 mm

ERCP and Spray Catheters



Special Features:

- Suitable for guide wire (ERCP catheter)
- X-ray resistant tip (ERCP catheter)
- Mandrel for anti-kink protection (ERCP and spray catheter)



110260-05



110260-05 **ERCP Catheter**, filliform, with X-ray ring, with double LUER-Lock connector and mandrel, for guide wire 0.035", working length 200 cm, sterile, for single use, package of 5, for use with flexible endoscopes with working channels as of diameter 2 mm



110261-10 **Spray Catheter**, axial atomization, working length 180 cm, sterile, for single use, package of 10, for use with flexible endoscopes with working channels as of diameter 2 mm

110262-10 **Same**, working length 230 cm

Guide Wire, Bite Protector



Special Features:

- Good visibility under X-ray thanks to stainless steel wire
- LubriSkin™ surface for non-stick, easy-glide wire



110970-05



110970-05

Guide Wire 0.035", straight flexible tip, other side rigid, PTFE-coated, in dispenser, length 300 cm, sterile, for single use, package of 5

Special Features:

- Optimal attachment due to wide, latex-free rubber strap
- Side openings offering additional manipulation if required
- Patient-friendly concave shape



110250-100

Bite Protector, dark green, with rubber strap, for single use, package of 100



Special Features:

- Excellent hygienic safety thanks to double-sided brush and single-use product
- Rounded tips to protect the endoscope from damage



110910-50



110910-50 **Cleaning Brush**, with double-sided brush, length 220 cm, brush diameter 5 mm, unsterile, for single use, package of 50, for use with flexible endoscopes with working channel diameters 2.8 – 4.2 mm



110915-50 **Cleaning Brush**, with double-sided brush, length 220 cm, brush diameter 3 mm, unsterile, for single use, package of 50, for use with flexible endoscopes with working channel diameters 2 – 2.3 mm



110917-50 **Cleaning Brush**, with double-sided brush, length 220 cm, brush diameter 1.5 mm, unsterile, for single use, package of 50, for use with flexible endoscopes with a working channel diameter of 1.2 mm



110920-10 **Biofilm Removal Device Cleaning Brush**, flocked, length 200 cm, unsterile, for single use, package of 10, for use with flexible endoscopes with a working diameter of 1.2 mm



Special Features:

- Brush filaments become softer from distal to proximal to remove coarse and fine debris during each brushing process, thus reducing the risk of biofilm
- Distally conical brush head
- Distal brush head is green to ensure safe insertion of the distal end
- In the case of thin-lumened cleaning brushes, the distal brush head has been replaced by two proximally mounted brush heads to make insertion into the working channel easier
- Brush tip end ensures maximum protection of the working channel
- Clear and unambiguous identification of the working channel diameter through color coding
- Individual intermediate sizes adapted to working channel length and diameter for time-saving and hygienically safe reprocessing
- Practical dispenser box with perforated individual packaging for easy removal
- Ready for use
- User-friendly design
- Enhanced hygiene safety
- No risk of cross-contamination
- Time savings by eliminating the need to reprocess reusable cleaning brushes
- Cleaning effectiveness proven by standard regulations

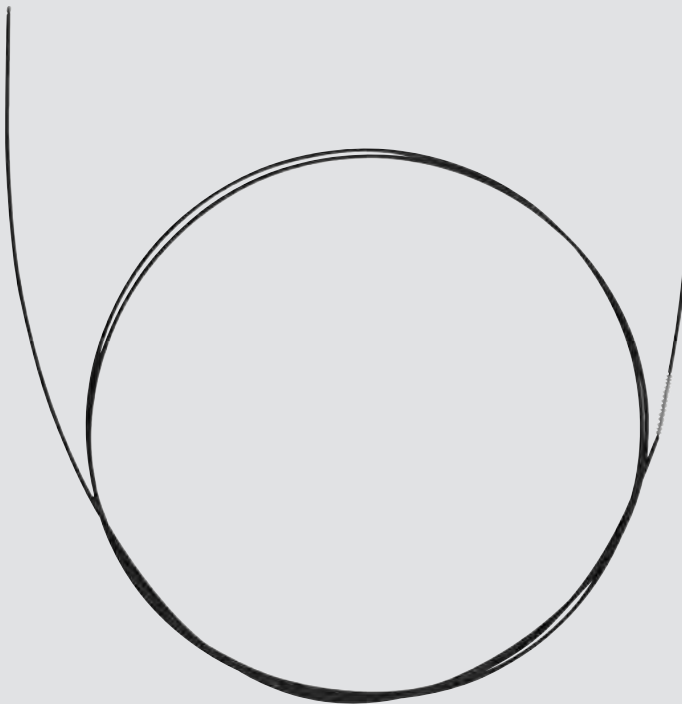

110930-50



Cleaning Brushes, for working channel sizes 1.2 – 1.5 mm:

- | | |
|-----------|--|
| 110930-50 | Biofilm Removal Device Cleaning Brush , length 90 cm, brush diameter 1.7 mm, unsterile, for single use, package of 50, for use with flexible endoscopes with working channel diameters 1.2 – 1.5 mm |
| 110931-50 | Same , length 125 cm |
| 110932-50 | Same , length 200 cm |



Cleaning Brushes, for working channel sizes 2 – 2.3 mm:

- 110940-50 **Cleaning Brush**, with double-sided brush, length 90 cm, brush diameter 2.6 mm, unsterile, for single use, package of 50, for use with flexible endoscopes with working channel diameters 2 – 2.3 mm
- 110941-50 **Same**, length 120 cm
- 110942-50 **Same**, length 160 cm

Cleaning Brushes, for working channel sizes 2.6 – 3 mm:

- 110950-50 **Cleaning Brush**, with double-sided brush, length 120 cm, brush diameter 3.2 mm, unsterile, for single use, package of 50, for use with flexible endoscopes with working channel diameters 2.6 – 3 mm
- 110951-50 **Same**, length 165 cm
- 110952-50 **Same**, length 250 cm

Cleaning Brushes, for working channel sizes 3.2 – 4.2 mm:

- 110960-50 **Cleaning Brush**, with double-sided brush, length 140 cm, brush diameter 4.5 mm, unsterile, for single use, package of 50, for use with flexible endoscopes with working channel diameters 3.2 – 4.2 mm
- 110961-50 **Same**, length 190 cm
- 110962-50 **Same**, length 230 cm



LAPAROSCOPY IN SURGERY, GYNECOLOGY, UROLOGY

VERESS PNEUMOPERITONEUM
NEEDLES, TROCARS FOR
LAPAROSCOPY 82-83

TROCAR VALVES 84

FinRay FORCEPS INSERT,
CLICK'line FORCEPS INSERTS AND
SCISSORS INSERTS,
KNIFE INSERT 85-89

INSUFFLATION TUBING SETS,
GAS FILTERS AND ACCESSORIES,
SMOKE EVACUATION 90-96

IRRIGATION/SUCTION HANDLES AND
IRRIGATION/SUCTION PROBES 97

TUBING SETS 98-104

EXTRACTION BAGS,
ACCESSORIES FOR
ROTOCUT G1/G2 105-109

SPARE PARTS AND
ACCESSORIES 110-115

VERESS Pneumoperitoneum Needles



Special Features:

- Choice between male or female LUER-Lock connector to a three-way stopcock (020180-01, 020190-01)

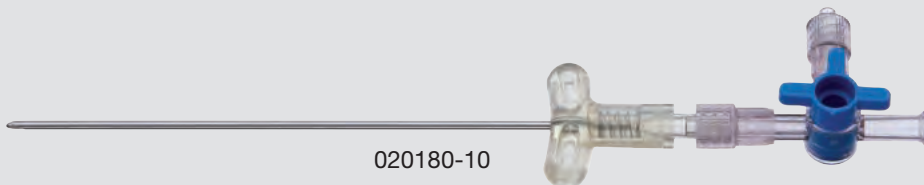

020180-10

- 020180-10 VERESS **Pneumoperitoneum Needle**, insufflation stopcock with male and female LUER-Locks, length 120 mm, sterile, for single use, package of 10
- 020181-10 VERESS **Pneumoperitoneum Needle**, length 120 mm, sterile, for single use, package of 10
- 020190-10 VERESS **Pneumoperitoneum Needle**, insufflation stopcock with male and female LUER-Locks, length 150 mm, sterile, for single use, package of 10



Special Features:

- Cost-effective, economical trocars
- Light weight helps maintain trocar positioning
- Threaded sleeves for better anchoring in the abdominal wall
- Transparent sleeves provide better visualization
- Reducer caps included (except for 020206-30)

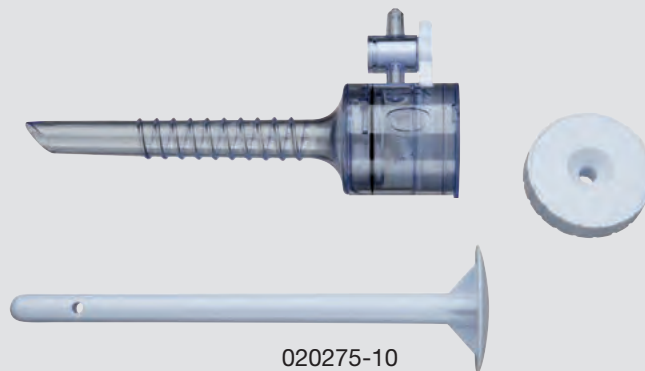

020275-10

- 020206-30 **Trocar**, with conical trocar tip, for instruments with diameter 5 mm, length 100 mm, sterile, for single use, package of 30
- 020274-10 **Trocar**, with conical trocar tip and insufflation stopcock, for instruments with diameter 10 mm, length 100 mm, including 5 mm reducer cap, sterile, for single use, package of 10
- 020275-10 **Trocar**, with blunt trocar tip (for the Hasson technique) and insufflation stopcock, for instruments with diameter 10 mm, length 100 mm, including 5 mm reducer cap, sterile, for single use, package of 10
- 020276-10 **Trocar**, with conical trocar tip and insufflation stopcock, for instruments with diameter 12 mm, length 100 mm, including 5 mm reducer cap, sterile, for single use, package of 10

Trocar Valves

Sizes 6 and 11 mm



Special Features:

- Trocar valves protect instruments and facilitate extracorporeal knotting techniques
- Light weight makes it easier to maintain positioning

Trocar valves size 6 mm for use with telescopes and instruments sizes 5 mm and 5.5 mm

Trocar valves size 11 mm for use with telescopes and instruments size 10 mm

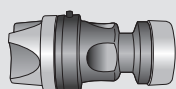

021108-05 **Trocar Valve**, size 6 mm, sterile, for single use, package of 5, for use with cannulas size 6 mm

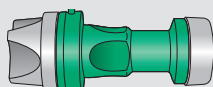

021109-05 **Trocar Valve**, size 11 mm, sterile, for single use, package of 5, for use with cannulas size 11 mm

FinRay Forceps Insert



The sterile FinRay forceps insert is the ideal instrument for the safe and atraumatic dissection and grasping of sensitive tissue. It is not approved for use with HF current! The bionic forceps insert was designed to replicate the optimized structure of the fish fin that has

developed and evolved over millions of years. In comparison to conventional forceps, the risk of injury and crushing is reduced to a minimum through this bionic approach.

Special Features:

- **Atraumatic jaws:** Allow manipulation of even very sensitive tissue
- **Sensitive force transmission thanks to optimal force distribution:** Time savings through faster and more secure manipulation
- **Finger-like grasping mechanism:** In contrast to conventional forceps that close from the front to the back, the reverse jaw-closing mechanism allows precise grasping of various tissue structures
- **Optimal ergonomics in combination with the CLICK'linē system**

For use with CLICK'linē sheaths and metal handles in combination with trocars size 11 mm

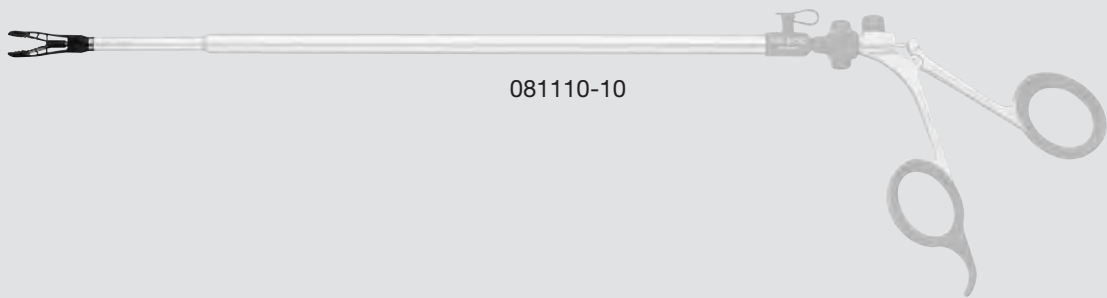

081110-10

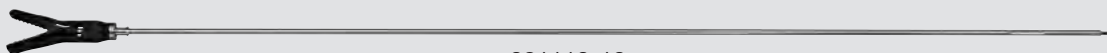

081110-10



081110-10

FinRay Forceps Insert, size 10 mm, working length 36 cm, sterile, for single use, package of 10, for use with CLICK'linē sheaths and handles in combination with trocars size 11 mm

CLICK'line® Forceps Inserts and Scissors Inserts



For use with CLICK'line® handles (e.g., 33151) and CLICK'line® outer sheaths (e.g., 33300) in combination with trocars size 6 mm

STERILE

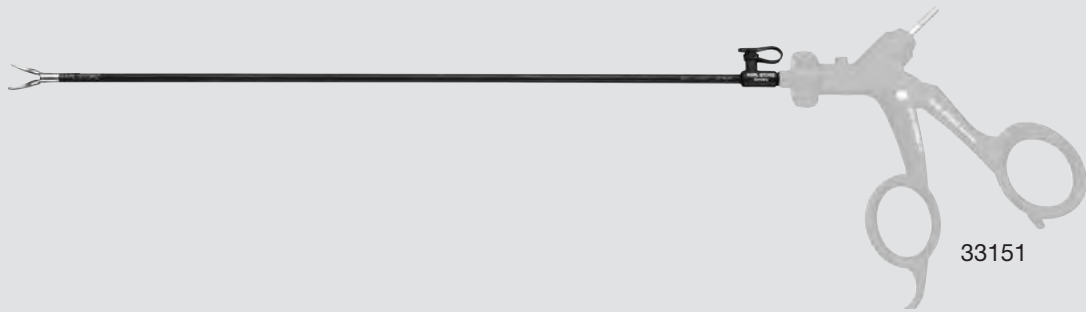
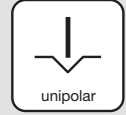

34310 MA-S **CLICK'line® Scissors Insert**, for scissors, double action jaws, serrated jaws, spoon-shaped, size 5 mm, length 36 cm, sterile, for single use, package of 10



34310 MS-S **CLICK'line® Scissors Insert**, for METZENBAUM scissors, double action jaws, curved, size 5 mm, length 36 cm, sterile, for single use, package of 10

CLICK'line® Forceps Inserts and Scissors Inserts







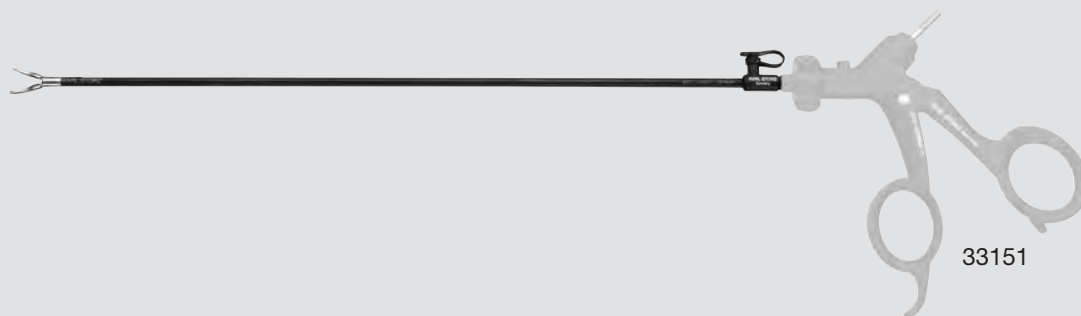
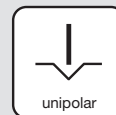

For use with CLICK'line® handles (e.g., 33151) and CLICK'line® outer sheaths (e.g., 33300) in combination with trocars size 6 mm

STERILE

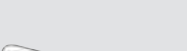
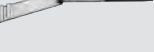

33151

- | | | |
|---|------------|---|
|  | 33310 MD-S | CLICK'line® Forceps Insert , for KELLY dissecting and grasping forceps, double action jaws, size 5 mm, length 36 cm, sterile, for single use, package of 10 |
|  | 33310 ML-S | CLICK'line® Forceps Insert , for KELLY dissecting and grasping forceps, double action jaws, size 5 mm, length 36 cm, sterile, for single use, package of 10 |
|  | 33310 C-S | CLICK'line® Forceps Insert , for bowel grasper, double action jaws, fenestrated, size 5 mm, length 36 cm, sterile, for single use, package of 10 |
|  | 33310 CK-S | CLICK'line® Forceps Insert , for bowel grasper, length of jaws 16 mm, double action jaws, fenestrated, size 5 mm, length 36 cm, sterile, for single use, package of 10 |
|  | 33310 CC-S | CLICK'line® Forceps Insert , for CROCE-OLMI grasping forceps, single action jaws, atraumatic, fenestrated, curved, size 5 mm, length 36 cm, sterile, for single use, package of 10 |
|  | 33310 AF-S | CLICK'line® Forceps Insert , for grasping forceps, double action jaws, atraumatic, size 5 mm, length 36 cm, sterile, for single use, package of 10 |
|  | 33310 G-S | CLICK'line® Forceps Insert , for grasping forceps, double action jaws, size 5 mm, length 36 cm, sterile, for single use, package of 10 |
|  | 33310 ON-S | CLICK'line® Forceps Insert , for grasping forceps, single action jaws, with especially fine atraumatic serration, fenestrated, size 5 mm, length 36 cm, sterile, for single use, package of 10 |
|  | 33310 ME-S | CLICK'line® Forceps Insert , for MANHES grasping forceps, single action jaws, for atraumatic and accurate grasping, size 5 mm, length 36 cm, sterile, for single use, package of 10 |

Scissors Inserts with Outer Sheath

Size 5 mm



Special Features:

- Scissor blades are always sharp and/or with optimal cutting effect
- Sterile packed for immediate use in the OR
- Proven scissor blade design
- Compatible with all handles from the CLICK'line® series (without ratchet)
- Packed in individual blister packs and delivered in packages of 10 in a dispenser box
- Cost-effective solution: "Single use meets reusable"

For use with CLICK'line® handles without ratchets (e.g., 33151) in combination with trocars size 6 mm

STERILE

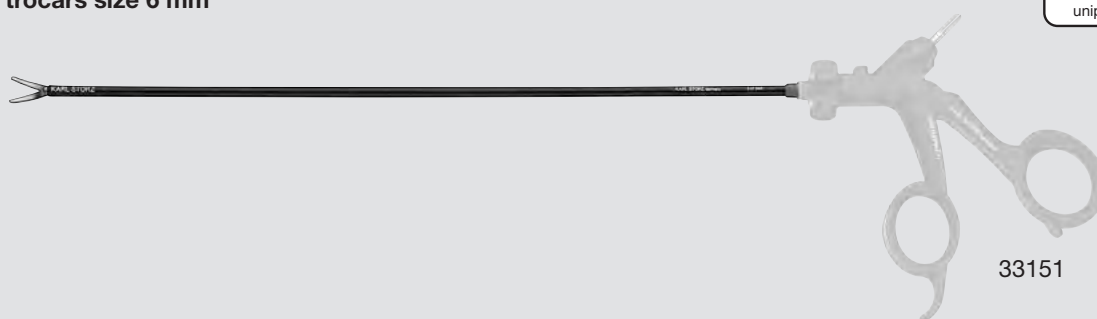

33151



34310 MA-D



34310 MA-D **CLICK'line® Scissors Insert with Outer Sheath**, curved, double action jaws, spoon-shaped jaws, size 5 mm, length 36 cm, sterile, for single use, package of 10



34310 MS-D **CLICK'line® METZENBAUM Scissors Insert with Outer Sheath**, curved, double action jaws, size 5 mm, length 36 cm, sterile, for single use, package of 10

Knife Insert

for pyloromyotomy



For use with Pyloric Knife, size 3 mm, length 10 cm, 26167 DRS



26167 DRS



26167 KRS



26167 KRS **Knife Insert**, unsterile, for single use,
package of 10

Insufflation Tubing Sets, Gas Filters and Accessories



Special Features:

- Protects patients and equipment against contamination
- Gas flow of up to 50 l/min
- Preheated gas for better view and patient comfort (031210-10)

For use with electronic ENDOFLATOR®, THERMOFLATOR®, ENDOFLATOR® 40 and ENDOFLATOR® 50



031122-25



031200-10



031210-10

031122-25 **Gas Filter**, with ISO connectors, hydrophobic on both sides, sterile, for single use, package of 25, for use with insufflation units with a maximum gas flow of 50 l/min (Electronic ENDOFLATOR®, THERMOFLATOR®, ENDOFLATOR® 40 and ENDOFLATOR® 50)

031200-10 **Insufflation Tubing Set with Gas Filter**, length 300 cm, hydrophobic on both sides, sterile, for single use, package of 10, for use with insufflation units with a maximum gas flow of 50 l/min (Electronic ENDOFLATOR®, THERMOFLATOR®, ENDOFLATOR® 40 and ENDOFLATOR® 50)

031210-10 **Insufflation Tubing Set with Gas Filter**, length 300 cm, heatable, hydrophobic on both sides, sterile, for single use, package of 10, for use with ENDOFLATOR® 50

Insufflation Tubing Sets, Gas Filters and Accessories



Special Features:

- Protects patients and equipment against contamination
- Two patient-side tubing connectors for gas flow up to 20 l/min with LUER-Lock
- Possible to use only one tubing connector by using a roller clamp



For use with electronic ENDOFLATOR®, THERMOFLATOR®, ENDOFLATOR® 40 and ENDOFLATOR® 50

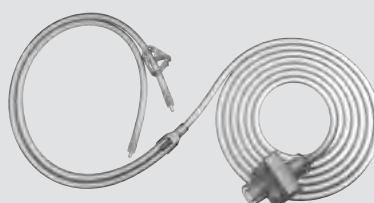

031622-10

031622-10 **Insufflation Tubing Set with Gas Filter**, length 400 cm, two patient-side tube connections, hydrophobic on both sides, sterile, for single use, package of 10, for use with insufflation units with a maximum gas flow of 30 l/min (Electronic ENDOFLATOR®, THERMOFLATOR®, ENDOFLATOR® 40 and ENDOFLATOR® 50)

Insufflation Tubing Sets, Gas Filters and Accessories



Special Features:

- Protects patients and equipment against contamination
- Gas flow of up to 30 l/min

For use with electronic ENDOFLATOR® and THERMOFLATOR®

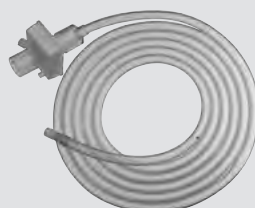

031222-10

031222-10 **Insufflation Set with Gas Filter**, length 320 cm, hydrophobic on both sides, sterile, for single use, package of 10, for use with insufflation units with a maximum gas flow of 30 l/min (Electronic ENDOFLATOR®, THERMOFLATOR®)

including:
10x **Gas Filter with Insufflation Tube**, sterile
Adaptor with Tube
Adaptor

Accessories

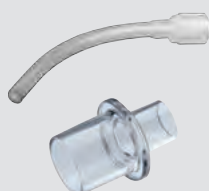

031822-01 **Adaptor**, with 15 cm tube, unsterile, for use with Filters 031122-25 and 031222-10 in combination with insufflation units without ISO connectors

031922-10 **Adaptor**, size 15M/22M, unsterile, package of 10, for use with Filters 031122-25 and 031222-10 for THERMOFLATOR® when using the OPTITHERM® heating element



Insufflation Tubing Sets, Gas Filters and Accessories



Special Features:

- Protects patients and equipment against contamination
- Patient- or unit-side connection possible



For use with ARTHROFLATOR®, CO₂ ENDOFLATOR®, electronic ENDOFLATOR®, N₂O ENDOFLATOR® and LAPAROFLATOR®



031121-10

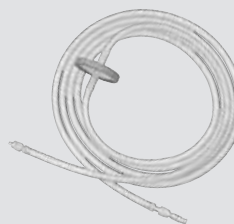

031221-10

- 031121-10 **Gas Filter**, with patient-side tube and male LUER-Lock, hydrophobic on both sides, sterile, for single use, package of 10, for use with insufflation units with a maximum gas flow of 10 l/min (ARTHROFLATOR®, CO₂ ENDOFLATOR®, Electronic ENDOFLATOR®, N₂O ENDOFLATOR® and LAPAROFLATOR®)
- 031221-10 **Insufflation Tubing Set with Gas Filter**, length 300 cm, with male and female LUER-Locks, hydrophobic on both sides, sterile, for single use, package of 10, for use with insufflation units with a maximum gas flow of 10 l/min (ARTHROFLATOR®, CO₂ ENDOFLATOR®, Electronic ENDOFLATOR®, N₂O ENDOFLATOR® and LAPAROFLATOR®)

Smoke Evacuation

Tubing Set



Special Features:

- Connector for second suction tube for parallel suction of fluids
- Roller clamp for regulating the suction pressure of smoke and gas

For use with S-PILOT®

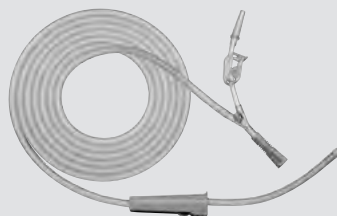

031447-10

031447-10 **Tubing Set for Smoke, Gas and Fluid Suction**, with connector for second suction tube, sterile, for single use, package of 10, for use with S-PILOT®, for laparoscopy

Smoke Evacuation

Smoke Evacuation Filter



Special Features:

- Effective filtration at a rate of 99.9999 %
- Protects the patient and the surgical team against viruses, bacteria and harmful particles



For use with S-PILOT®



031111-10

031111-10 **Smoke Evacuation Filter**, unsterile,
for single use, package of 10

Smoke Evacuation

Smoke Evacuation Filter



Special Features:

- Effective filtration at a rate of 99.9999 %
- Protects the patient and the surgical team against viruses, bacteria and harmful particles

For use with trocars with LUER-Lock connectors



031110-10

031110-10 **Smoke Evacuation Filter Set**, with 50 cm tube, with male LUER-Lock, sterile, for single use, package of 10, for use with trocars with LUER-Lock connector

Irrigation/Suction Handles and Irrigation/Suction Probes



Special Features:

- Color coding (blue=irrigation, red=suction)
- Ergonomic design

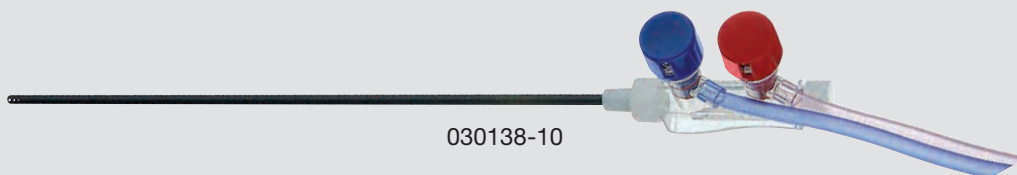

030138-10

Irrigation/Suction Handles, with suction tubes

- 030138-10 **Irrigation/Suction Handle**, with suction tube and irrigation/suction probe, sterile, for single use, package of 10, for use with irrigation tubing sets with patient-side silicone tube, inner diameter 5 mm
- 030238-10 **Irrigation/Suction Handle**, with irrigation and suction tube and irrigation/suction probe, sterile, for single use, package of 10, for use with irrigation liquid bags (without pump)

Irrigation/Suction Probes

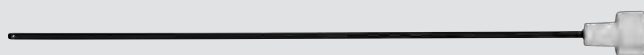

030903-10

- 030903-10 **Irrigation/Suction Probe**, diameter 3 mm, length 250 mm, 4 holes, sterile, for single use, package of 10, for use with Irrigation/Suction Handles 030138-01 and 030238-01



030905-10

- 030905-10 **Irrigation/Suction Probe**, diameter 5 mm, length 450 mm, 16 holes, sterile, for single use, package of 10, for use with Irrigation/Suction Handles 030138-01 and 030238-01



030910-10

- 030910-10 **Irrigation/Suction Probe**, diameter 10 mm, length 330 mm, 16 holes, sterile, for single use, package of 10, for use with Irrigation/Suction Handles 030138-01 and 030238-01

Suction and Irrigation Pumps for use with Irrigation/Suction Handles and Irrigation/Suction Probes
see LAPAROSCOPY IN SURGERY, GYNECOLOGY, UROLOGY catalog

Tubing Sets

for irrigation and suction



For use with HAMOU® ENDOMAT® 26 3310 20 or ENDOMAT® LC SCB



031218-10



031219-10

- 031218-10 **Complete Tubing Set**, with two puncture cannulas, sterile, for single use, package of 10, for use with Handles 37112 A (straight) and 37113 A (pistol grip) as well as 37112 RV in combination with HAMOU® ENDOMAT® 26 3310 20, for laparoscopy
- 031219-10 **Complete Tubing Set**, with two puncture cannulas, sterile, for single use, package of 10, for use with Handles 37112 A (straight) and 37113 A (pistol grip) as well as 37112 RV in combination with ENDOMAT® LC SCB

Tubing Sets

for irrigation and suction



For use with Handles 30810 and/or 37112 A (straight),
37113 A (pistol grip) and 37112 RV



031132-10



031134-10



031133-10



031233-10

- 031132-10 **Tubing Set**, sterile, for single use, package of 10, for use with Handle 30810
- 031133-10 **Tubing Set**, sterile, for single use, package of 10, for use with Handles 37112 A (straight) and 37113 A (pistol grip) und 37112 RV
- 031134-10 **Tubing Set**, sterile, for single use, package of 10, for use with Handles 37112 A (straight) and 37113 A (pistol grip) as well as 37112 RV in combination with silicone tube inner diameter 5 mm at the patient end
- 031233-10 **Tubing Set**, extra long, sterile, for single use, package of 10, for use with Handles 37112 A (straight), 37113 A (pistol grip) and 37112 RV

Tubing Sets

for irrigation and suction



Special Features:

- No risk of confusion when placing the connectors



For use with ENDOMAT® SELECT or HAMOU® ENDOMAT® SCB 26 3311 20-1



031524-10



030647-10

- 031524-10 **Tubing Set for Irrigation, FC, sterile, for single use, package of 10, for use with HAMOU® ENDOMAT® SCB 26 3311 20-1 and ENDOMAT® SELECT**
- 030647-10 **Tubing Set for Suction, DS, sterile, for single use, package of 10, for use with ENDOMAT® SELECT**

Tubing Sets

for irrigation and suction



Special Features:

- No risk of confusion when placing the connectors

For use with **ENDOMAT® SELECT** or **HAMOU® ENDOMAT® SCB 26 3311 20-1**



031524-10



031524-10 **Tubing Set for Irrigation, FC, sterile, for single use, package of 10, for use with HAMOU® ENDOMAT® SCB 26 3311 20-1 and ENDOMAT® SELECT**



030547-01



030547-01 **Tubing Set for Suction, 150 cm, with EXTRA-LARGE LUER-Lock, unsterile, for use with HAMOU® ENDOMAT® SCB 26 3311 20-1**

Tubing Sets

Irrigation Tubing Sets



Special Features:

- Optical product matching thanks to clear color coding (red)
- Automatic product recognition and mode selection via the pump (LAP mode)

For use with HAMOU® ENDOMAT® 26 3310 20 or LAPAROMAT®



031118-10



031141-10



031159-10

- 031118-10 **Tubing Set**, with two puncture cannulas, sterile, for single use, package of 10, for use with HAMOU® ENDOMAT® 26 3310 20, for laparoscopy
- 031141-10 **Tubing Set**, with two Care-Lock connectors, sterile, for single use, package of 10, for use with HAMOU® ENDOMAT® 26 3310 20, for laparoscopy
- 031159-10 **Tubing Set**, with two puncture cannulas, sterile, for single use, package of 10, for use with LAPAROMAT®, for laparoscopy

Tubing Sets

Pump Tubing Day Set and Patient Tube



Special Features:

- Optical product matching thanks to clear color coding (red)
- Automatic product recognition and mode selection via the pump (LAP mode)

For use with HAMOU® ENDOMAT® 26 3310 20



031168-10

STERILE

031168-10 **Pump Tubing Day Set**, with two puncture cannulas, sterile, package of 10, for use with HAMOU® ENDOMAT® 26 3310 20, for laparoscopy, in combination with Patient Tube 031162-10

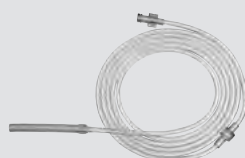

031162-10

STERILE

031162-10 **Patient Tube**, sterile, for single use, package of 10, for use with Pump Tubing Day Set 031161-10, 031167-10, 031168-10, 031261-10 and 031767-10

Tubing Sets

Insertion Adaptors



For use with CADIERE Suction and Irrigation Handle 38112 C



031135-10



031136-10

- 031135-10 **Insertion Adaptor**, with LUER-Lock connector and tube olive for suction and irrigation, sterile, for single use, package of 10, for use with CADIERE Suction and Irrigation Handle 38112 C
- 031136-10 **Insertion Adaptor and Suction Tube**, with LUER-Lock connector, sterile, for single use, package of 10, for use with CADIERE Suction and Irrigation Handle 38112 C

Extraction Bags



Special Features:

- One extraction bag pre-packaged in an insertion aid: Easy insertion through 10 mm trocar
- Easy to insert extraction bag via a pusher: Trocar can be used again for other instruments
- Self-opening extraction bag: No time-consuming bag opening necessary
- Tear-resistant and transparent material: High levels of safety and protection against contamination
- KÖCHLI bag extractor is recommended for easy retrieval of extraction bags

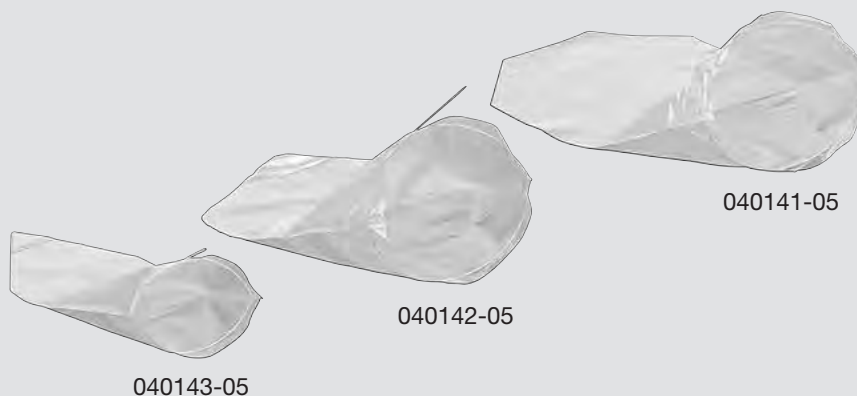

- 040141-05 **Extraction Bag**, opening diameter 11 cm, volume 1500 ml, sterile, for single use, package of 5, for use with trocars size 10 mm
- 040142-05 **Extraction Bag**, opening diameter 10 cm, volume 800 ml, sterile, for single use, package of 5, for use with trocars size 10 mm
- 040143-05 **Extraction Bag**, opening diameter 6 cm, volume 200 ml, sterile, for single use, package of 5, for use with trocars size 10 mm



Special Features:

- One extraction bag pre-packaged in an insertion aid: Easy insertion through 10 mm trocar
- Easy to insert extraction bag via a pusher: Trocar can be used again for other instruments
- Self-opening ENDOBAG: No time-consuming bag opening necessary
- Unique, patented shape: Straightforward retrieval of the ENDOBAG possible; enlargement of incision can be avoided if necessary
- Tear-resistant and transparent material: High levels of safety and protection against contamination

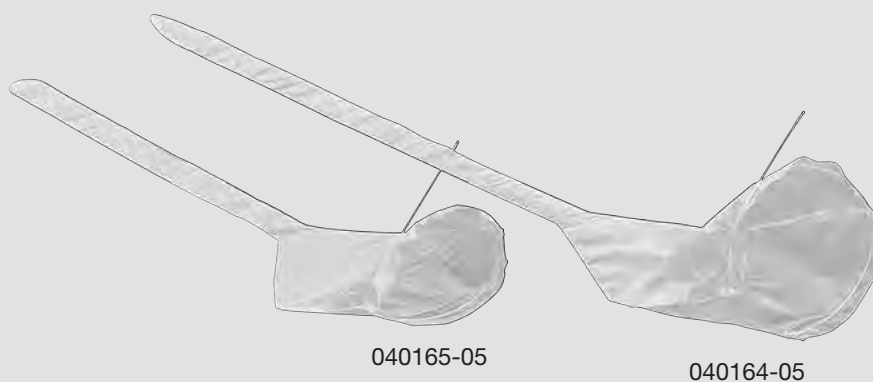

- 040164-05 **ENDOBAG Extraction Bag**, work volume 260 ml, filling volume 62 ml, working section opening diameter 10 cm, length of container section 35 cm, sterile, for single use, package of 5, for use with trocars size 10 mm
- 040165-05 **ENDOBAG Extraction Bag**, work volume 200 ml, filling volume 53 ml, working section opening diameter 7 cm, length of container section 20 cm, sterile, for single use, package of 5, for use with trocars size 10 mm

TRAPBAG Extraction Bag

with one-way trapping principle



Special Features:

- One extraction bag pre-packaged in an insertion aid: Easy insertion through 10 mm trocar
- Easy to insert extraction bag via a pusher: Trocar can be used again for other instruments
- Self-opening TRAPBAG: No time-consuming bag opening necessary
- Unique, patented fish trap seal: Leakage of fluids and tissue samples reduced
- Reuse and memory wire: Greater protection against contamination through double seal
- Tear-resistant and transparent material: High levels of safety

STERILE 

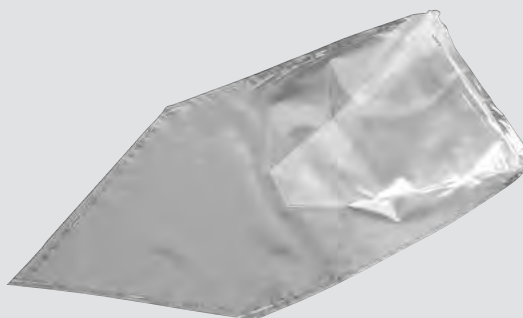

040343-05

040343-05 **TRAPBAG Extraction Bag**, opening diameter 6 cm, volume 200 ml, sterile, for single use, package of 5, for use with trocars size 10 mm

MiniTwin TRAPBAG

Mini Extraction Bag



Special Features:

- Two extraction bags pre-packaged in one two-tiered insertion aid: Separate insertion through 10 mm trocar
- Self-opening MiniTwin TRAPBAGs: No time-consuming bag opening necessary
- Bags are easily distinguishable: Tissue samples are easy to identify
- Unique, patented fish trap seal: Leakage of fluids and tissue samples reduced
- Reuse and memory wire: Greater protection against contamination through double seal



040302-05

040302-05 **MINITWIN TRAPBAG**, 2 mini extraction bags, opening diameter 3 cm, volume 20 ml, sterile, for single use, package of 5, for use with trocars size 10 mm

Accessories for ROTOCUT G1/G2

Morcellator Knives, Valve Plate



Special Features:

- Clear color coding facilitates identification of knives and outer sheaths
- Perfect cutting properties as product is for single use
- Additional working length for adipose patients

For use with Morcellator ROTOCUT G1/G2 26721 RC, 26723 RC and 26725 RC



26721 RC



091112-05



091115-05

091112-05 **Morcellator Knife**, diameter 11 mm, working length 9.5 cm, sterile, for single use, package of 5, color code: red

091115-05 **Morcellator Knife**, diameter 15 mm, working length 9.5 cm, sterile, for single use, package of 5, color code: black

091122-05 **Morcellator Knife**, diameter 11 mm, working length 12.5 cm, sterile, for single use, package of 5, color code: red

091125-05 **Morcellator Knife**, diameter 15 mm, working length 12.5 cm, sterile, for single use, package of 5, color code: black



26720 P **Valve Plate**, package of 10



Spare Parts and Accessories

Valve Seals



Size 2.5 mm

For use with cannula size 2.5 mm, 11603 G5



11603 G5

11603-XV2 **Valve Seal**, for single use, package of 10, color code: blue

Size 3.5 mm

For use with cannulas sizes 3 and 3.5 mm, 30114 G5, 30114 G6 and 30114 RT

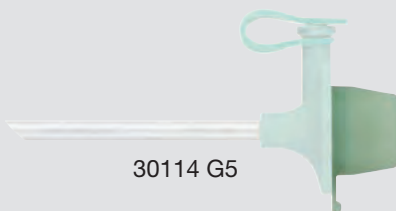

30114 G5

30114-XV3 **Valve Seal**, for single use, package of 10, color code: green

Size 6 mm

For use with cannulas size 6 mm, 30160 G5, 30160 G6, 30160 RT and S-PORT® Seal 23030 SA



30160 G5

30160-XV5 **Valve Seal**, for single use, package of 10, color code: black

Spare Parts and Accessories

Valve Seals



Size 11 mm

For use with cannulas size 11 mm, 30103 G6

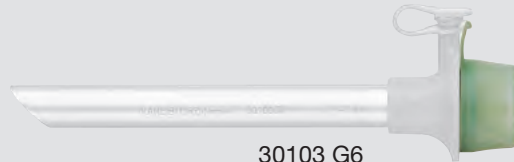

30103 G6



30103-XV10 **Valve Seal**, for single use, package of 10,
color code: green

Size 13.5 mm

For use with cannulas size 13.5 mm, 30108 G6

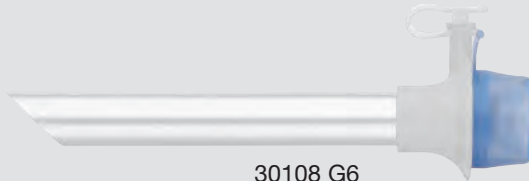

30108 G6



30108-XV13 **Valve Seal**, for single use, package of 10,
color code: blue

Spare Parts and Accessories

Telescope Stoppers



Size 3.9 mm

For use with telescopes with diameter 3.3 mm and ENDOTIP cannulas size 3.9 mm, 30117 T2

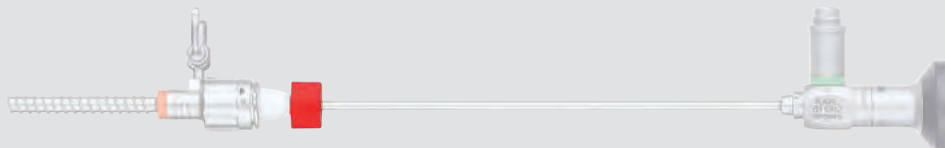

30117 T2



30117 CS

Telescope Stopper, size 3.9 mm, sterile, for single use, package of 12

Size 6 mm

For use with telescopes with diameter 5 mm and ENDOTIP cannulas size 6 mm, 30160 TK, 30160 TM, 30120 T8 and 30120 T9



30160 TM



30160 CS

Telescope Stopper, size 6 mm, sterile, for single use, package of 12

Size 11 mm

For use with telescopes with diameter 10 mm and ENDOTIP cannulas size 11 mm, 30103 TM and 30103 T6

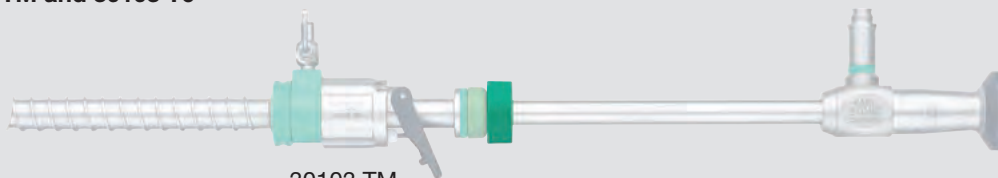

30103 TM



30103 CS

Telescope Stopper, size 11 mm, sterile, for single use, package of 12

Spare Parts and Accessories

Wound Protector



For use with LEROY S-PORT®, single portal surgery access system 23030 PA



23030 PA



23030 FA

23030 FA

Wound Protector, 90 x 90 cm, hole size 7 cm, sterile, for single use, package of 10

Spare Parts and Accessories

Spare Loops for SUPRALOOP, bipolar



For use with Handle 26183 NA and Outer Sheath 26183 MB

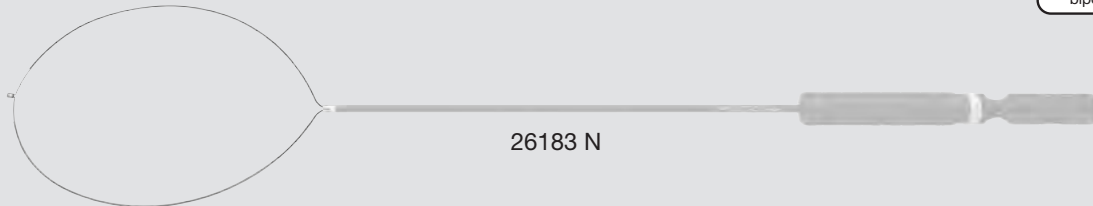

26183 N

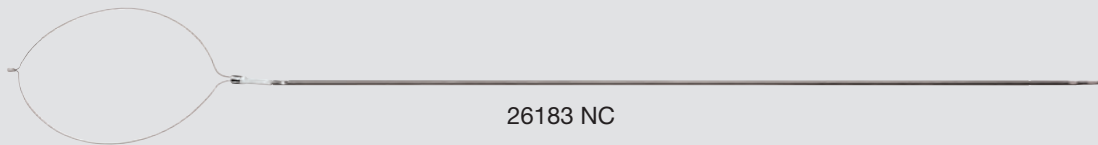

26183 NC

26183 NC **Spare Loop for SUPRALOOP**, bipolar, size 120 x 85 mm, unsterile, for single use, for use with Handle 26183 NA and Outer Sheath 26183 MB

26183 ND **Spare Loop for SUPRALOOP**, bipolar, size 200 x 150 mm, unsterile, for single use, for use with Handle 26183 NA and Outer Sheath 26183 MB

Further Loops and Electrodes see chapter 8 GYNECOLOGY

Spare Parts and Accessories

BRUCKER/MESSROGHLI SUPRALOOP Spare Loops, unipolar,
Spare Resection Loop, unipolar



For use with Handle 26183 MA and Outer Sheath 26183 MB

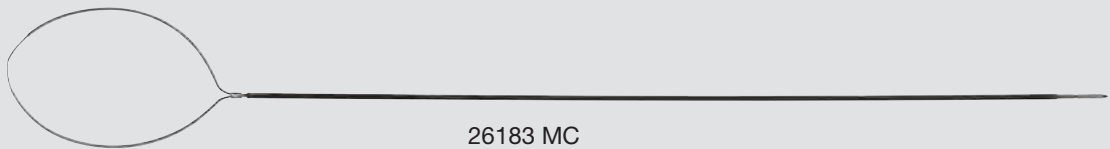
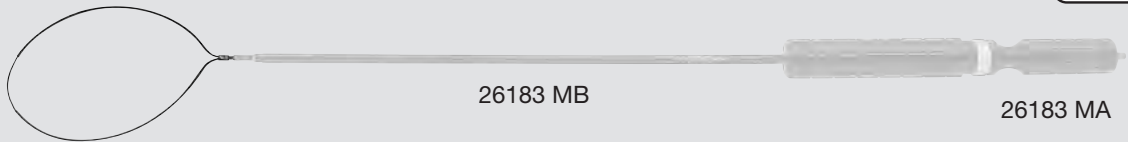

26183 MC **Spare Loop for SUPRALOOP**, unipolar, size 120 x 85 mm, unsterile, for single use, for use with Handle 26183 MA and Outer Sheath 26183 MB

26183 MD **Spare Loop for SUPRALOOP**, unipolar, size 200 x 150 mm, unsterile, for single use, for use with Handle 26183 MA and Outer Sheath 26183 MB

For use with Handle 26183 MA and Outer Sheath 26183 MB

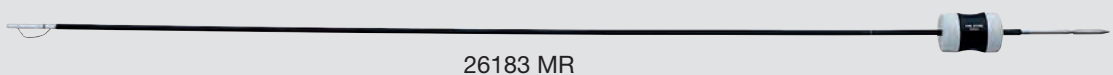
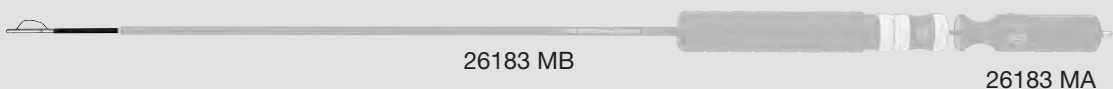

26183 MR **Spare Resection Loop**, for laparoscopic conization following supracervical hysterectomy, diameter 5 mm, for single use, for use with Handle 26183 MA and Outer Sheath 26183 MB

Further Loops and Electrodes see chapter 8 GYNECOLOGY

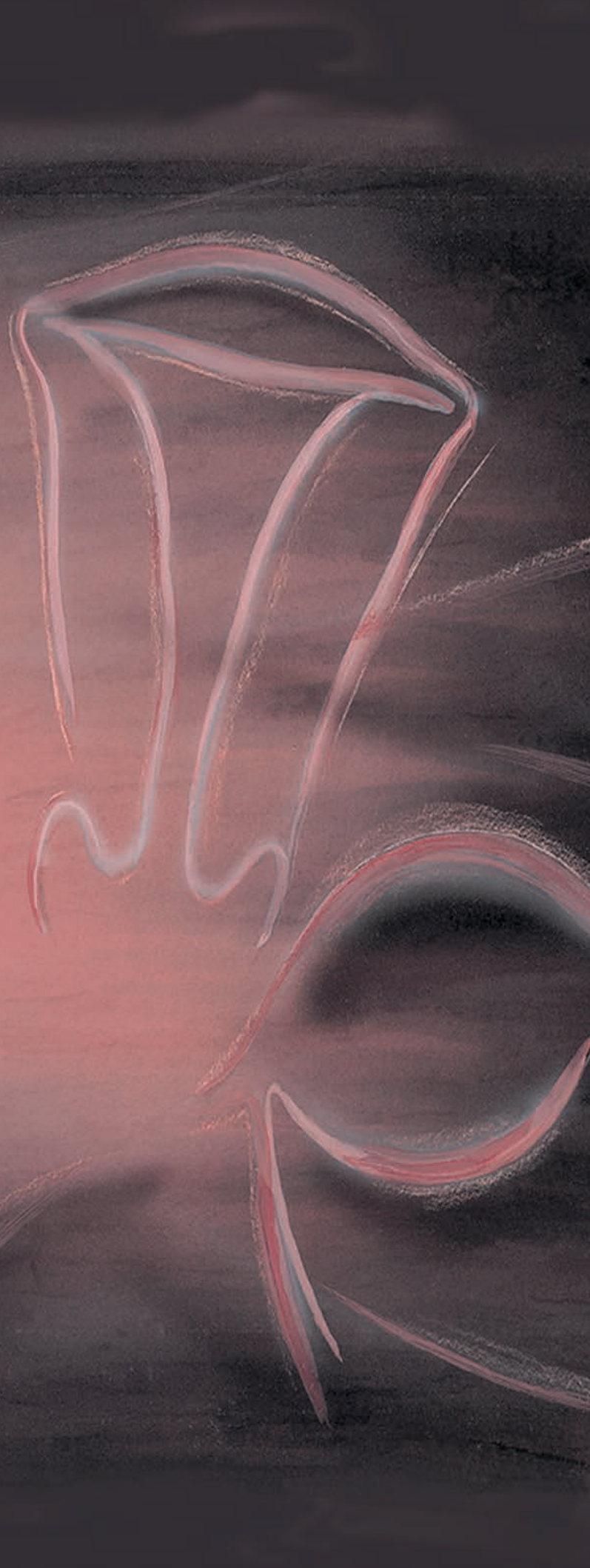

GYNECOLOGY

POLYPECTOMY LOOPS 118

UNIPOLAR ELECTRODES FOR
RESECTOSCOPE SYSTEMS 119-122

BIPOLAR ELECTRODES FOR
RESECTOSCOPE SYSTEMS 123-125

PUNCTURE NEEDLES,
INSTRUMENTS FOR
FETOSCOPY 126-128

ACCESSORIES FOR
BLOOD SAMPLING 129

INSUFFLATION TUBING SETS,
GAS FILTERS AND ACCESSORIES,
TUBING SETS 130-138

SPARE PARTS AND
ACCESSORIES 139

Polypectomy Loops



For use with BETTOCCHI® Polypectomy Loop 26159 L



26159 L

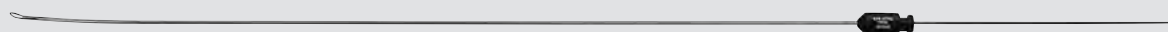

26159 LC



26159 LC

Spare Loop, unipolar, 5 Fr., length 34 cm, for use with BETTOCCHI® Polypectomy Loop 26159 L

Unipolar Electrodes for Resectoscope Systems



Special Features:

- Easy product matching thanks to green color coding for 15 Fr.

STERILE



For use with 15 Fr. Resectoscopes



011010-10



011010-10

Unipolar Cutting Loop, 2 guide rods, 15 Fr., sterile, for single use, package of 10, for use with Working Element 26053 EB, color code: green

Unipolar Electrodes for Resectoscope Systems



Special Features:

- Easy product matching thanks to white color coding for 19/22 Fr.
- Single-use product guarantees functionality

STERILE



For use with 22 Fr. Resectoscopes

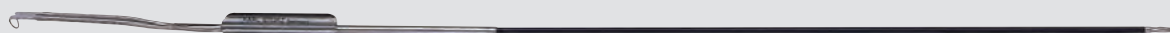

011220-10



011220-10

Unipolar Cutting Loop, angled, 1 guide rod, 22 Fr., sterile, for single use, package of 10, for use with Working Elements 26055 E and 27054 E, color code: white

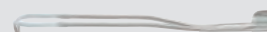

011223-10

Unipolar Coagulation Electrode, pointed, 1 guide rod, 22 Fr., sterile, for single use, package of 10, for use with Working Elements 26055 E and 27054 E, color code: white

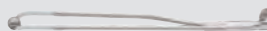

011224-10

Unipolar Coagulation Electrode, ball end, diameter 3 mm, 1 guide rod, 22 Fr., sterile, for single use, package of 10, for use with Working Elements 26055 E and 27054 E, color code: white

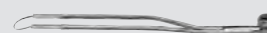

011222-10

Unipolar Cutting Loop, angled 25°, 1 guide rod, 22 Fr., sterile, for single use, package of 10, for use with Working Elements 26055 E and 27054 E, color code: white

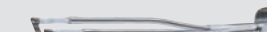

011221-10

Unipolar VAPORCUT® Electrode, band width 1.2 mm, 1 guide rod, 22 Fr., sterile, for single use, package of 10, for use with Working Elements 26055 E and 27054 E, color code: white

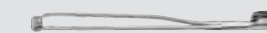

011225-10

Unipolar Roller Electrode, cylindrical, 1 guide wire, 22 Fr., sterile, for single use, package of 10, for use with Working Elements 26055 E and 27054 E, color code: white

Unipolar Electrodes for Resectoscope Systems



Special Features:

- Easy product matching thanks to yellow color coding for 24/26 Fr.
- Single-use product guarantees functionality

STERILE



For use with 24/26 Fr. Resectoscopes



011110-10



011110-10

Unipolar Cutting Loop, angled, 1 guide rod, 24/26 Fr., sterile, for single use, package of 10, for use with Working Elements 26050 D/E and 27050 C/D/E, color code: yellow



011111-10

Unipolar Coagulation Electrode, pointed, 1 guide rod, 24/26 Fr., sterile, for single use, package of 10, for use with Working Elements 26050 D/E and 27050 C/D/E, color code: yellow

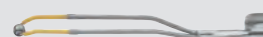

011112-10

Unipolar Coagulation Electrode, ball end, diameter 3 mm, 1 guide rod, 24/26 Fr., sterile, for single use, package of 10, for use with Working Elements 26050 D/E and 27050 C/D/E, color code: yellow

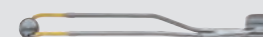

011113-10

Unipolar Coagulation Electrode, ball end, diameter 5 mm, 1 guide rod, 24/26 Fr., sterile, for single use, package of 10, for use with Working Elements 26050 D/E and 27050 C/D/E, color code: yellow

Unipolar Electrodes for Resectoscope Systems



Special Features:

- Easy product matching thanks to yellow color coding for 24/26 Fr.
- Single-use product guarantees functionality

STERILE



For use with 24/26 Fr. Resectoscopes



011110-10



011118-10 **Unipolar Cutting Loop**, longitudinal, 1 guide rod, 24/26 Fr., sterile, for single use, package of 10, for use with Working Elements 26050 D/E and 27050 C/D/E, color code: yellow

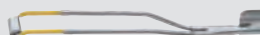

011119-10 **Unipolar Coagulation Electrode**, cylindrical, diameter 3 mm, 1 guide rod, 24/26 Fr., sterile, for single use, package of 10, for use with Working Elements 26050 D/E and 27050 C/D/E, color code: yellow



011120-10 **Unipolar Coagulation Electrode**, cylindrical, diameter 5 mm, 1 guide rod, 24/26 Fr., sterile, for single use, package of 10, for use with Working Elements 26050 D/E and 27050 C/D/E, color code: yellow



011121-10 **Unipolar VAPORCUT® Electrode**, band width 1.2 mm, 1 guide rod, 24/26 Fr., sterile, for single use, package of 10, for use with Working Elements 26050 D/E and 27050 C/D/E, color code: yellow

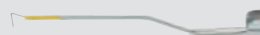

011122-10 **Unipolar Coagulation Needle Electrode**, angled, 1 guide rod, 24/26 Fr., sterile, for single use, package of 10, for use with Working Elements 26050 D/E, color code: yellow

Bipolar Electrodes for Resectoscope Systems



Special Features:

- Easy product matching thanks to green color coding for 15 Fr.
- Single-use product guarantees functionality

STERILE

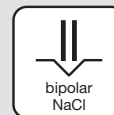

For use with 15 Fr. Resectoscopes

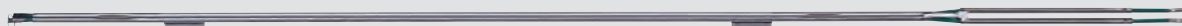

011050-10



011050-10

Bipolar Cutting Loop, 2 guide rods, 15 Fr., sterile, for single use, package of 10, for use with Working Element 26053 EB, color code: green

Bipolar Electrodes for Resectoscope Systems



Special Features:

- Easy product matching thanks to white color coding for 19/22 Fr.
- Single-use product guarantees functionality

STERILE

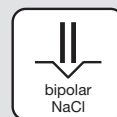

For use with 19/22 Fr. Resectoscopes



011250-10



011250-10

Bipolar Cutting Loop, 2 guide rods, 22 Fr., sterile, for single use, package of 10, for use with Working Elements 26055 EB and 27054 EB, color code: white



011251-10

Bipolar Coagulation Electrode, pointed, 2 guide rods, 22 Fr., sterile, for single use, package of 10, for use with Working Elements 26055 EB and 27054 EB, color code: white



011252-10

Bipolar Coagulation Electrode, ball end, 2 guide rods, 22 Fr., sterile, for single use, package of 10, for use with Working Elements 26055 EB and 27054 EB, color code: white

Bipolar Electrodes for Resectoscope Systems



STERILE

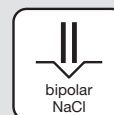

Special Features:

- Easy product matching thanks to yellow or yellow-orange color coding for 24/26 Fr.
- Universally usable for 12° and 30° telescopes
- Single-use product guarantees functionality

For use with 24/26 Fr. Resectoscopes



011160-10



011160-10

Bipolar Cutting Loop, 2 guide rods, 24/26 Fr., sterile, for single use, package of 10, for use with Working Elements 26040 DB/EB and 27040 DB/EB as well as 12° Telescopes 26105 FA/27005 FA and 30° Telescopes 26105 BA/27005 BA, color code: yellow



011161-10

Bipolar Cutting Loop, small, 2 guide rods, 24/26 Fr., sterile, for single use, package of 10, for use with Working Elements 26040 DB/EB and 27040 DB/EB as well as 12° Telescopes 26105 FA/27005 FA and 30° Telescopes 26105 BA/27005 BA, color code: yellow



011162-10

Bipolar Cutting Loop, longitudinal, 2 guide rods, 24/26 Fr., sterile, for single use, package of 10, for use with Working Elements 26040 DB/EB and 27040 DB/EB as well as 12° Telescopes 26105 FA/27005 FA and 30° Telescopes 26105 BA/27005 BA, color code: yellow-orange



011163-10

Bipolar Coagulation Electrode, pointed, 2 guide rods, 24/26 Fr., sterile, for single use, package of 10, for use with Working Elements 26040 DB/EB and 27040 DB/EB as well as 12° Telescopes 26105 FA/27005 FA and 30° Telescopes 26105 BA/27005 BA, color code: yellow



011156-10

Bipolar Coagulation Electrode, ball end, 2 guide rods, 24/26 Fr., sterile, for single use, package of 10, for use with Working Elements 26040 DB/EB and 27040 DB/EB as well as 12° Telescopes 26105 FA/27005 FA and 30° Telescopes 26105 BA/27005 BA, color code: yellow

Puncture Needles



For use with Operating Sheaths 11510 KD/KE/KI and
Miniature Straight Forward Telescope 11510 A

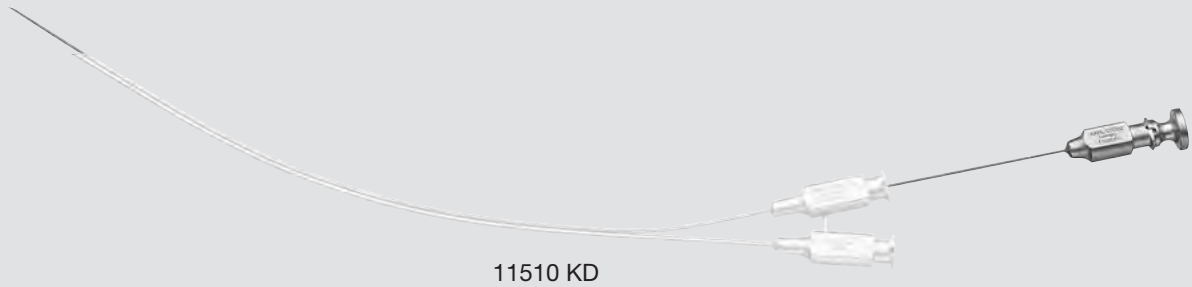

11510 KD



11510 KC

11510 KC **Puncture Needle**, diameter 0.6 mm, length 26.5 cm,
for single use, package of 6, for use with Operating
Sheaths 11510 KD/KE/KI

For use with Operating Sheath 11540 KEK and
Miniature Straight Forward Telescope 11540 AA

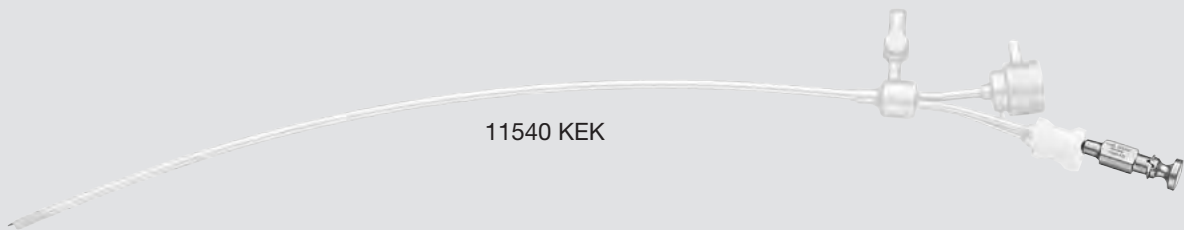

11540 KEK

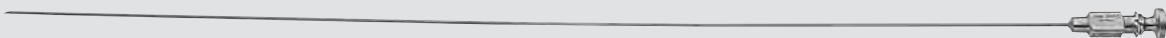

11540 KD

11540 KD **Puncture Needle**, diameter 0.9 mm, length 35 cm,
for single use, package of 6, for use with Operating
Sheath 11540 KEK

Puncture Needles and Tuohy Borst



For use with Miniature Straight Forward Telescopes 11506 AA and 11508 AA

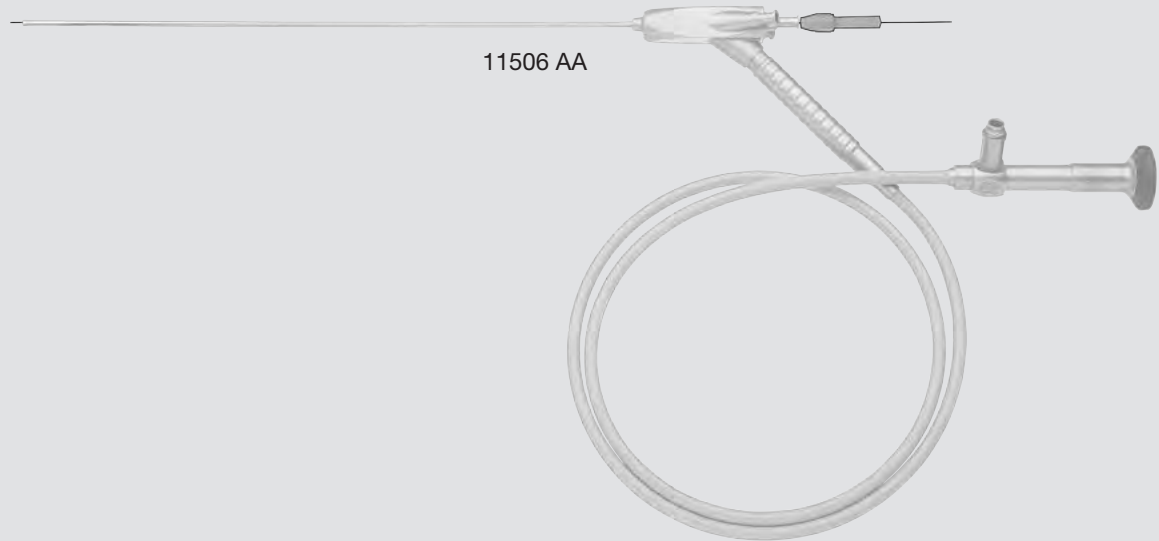

11506 AA

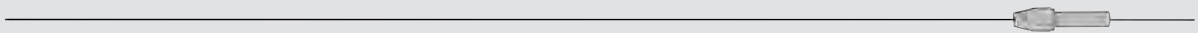

11506 P

11506 P **Puncture Needle**, sharp, with individually adjustable handle, length 50 cm, sterile, for single use, package of 10, for use with Miniature Straight Forward Telescopes 11506 AA and 11508 AA

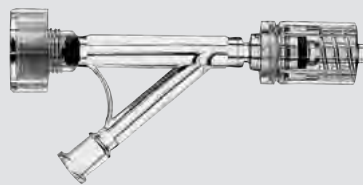

11510 V

11510 V **Tuohy Borst Y-Connector**, rotating, with one-way stopcock, sterile, for single use, package of 5



For use with Optical Grasping Forceps size 2.4 mm, 11540 FG

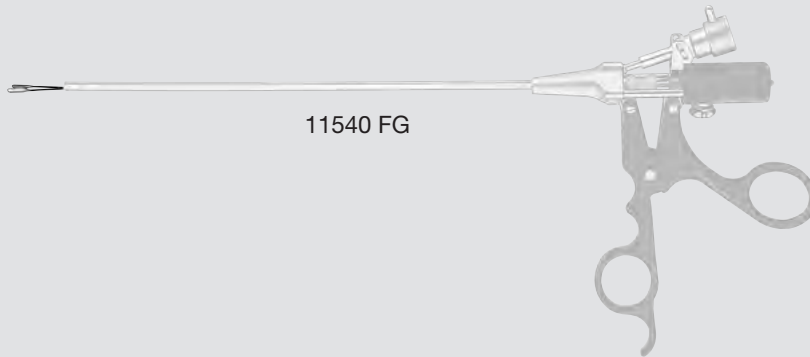

11540 FG

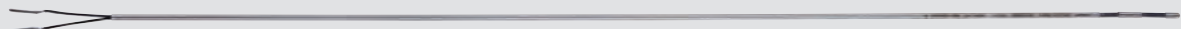

11540 FGE



11540 FGE

Working Insert, serrated, for single use, package of 5, for use with Bipolar Optical Grasping Forceps 11540 FG

For use with Bipolar Grasping Forceps size 2.4 mm, 26167 FG

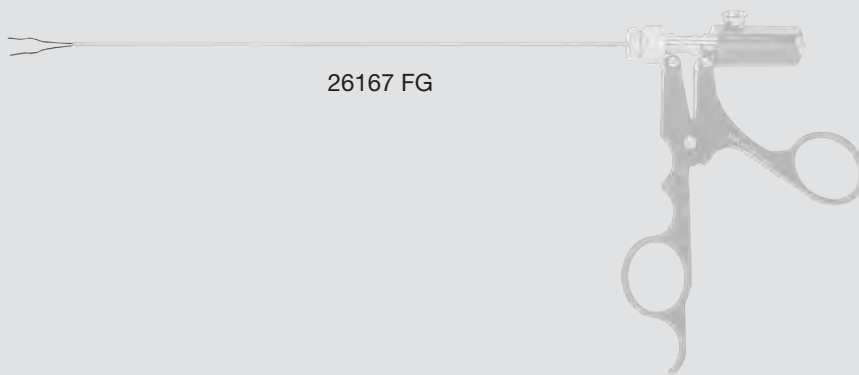

26167 FG



26167 FGE



26167 FGE

Working Insert, serrated, for single use, package of 5, for use with Bipolar Grasping Forceps 26167 FG

Accessories for Blood Sampling



For use with Knife Holder 26206

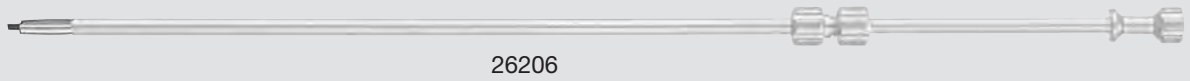

26206

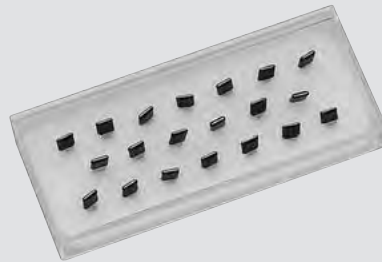

26207 M

26207 M

Micro Blood Sampling Knife, for single use,
package of 20, for use with Knife Holder 26206



For use with HAMOU® MICRO HYSTEROFLATOR SCB

STERILE 



031123-10

031123-10 **Gas Filter**, for fluid irrigation, with male LUER-Lock connector and female LUER-Lock connector, sterile, for single use, package of 10, for use with insufflation units with a maximum gas flow of 1 l/min (HAMOU® MICRO HYSTEROFLATOR SCB)

Tubing Sets

for irrigation and suction



Special Features:

- Monobloc connector eliminates confusion between irrigation and suction ports



For use with B.I.O.H.[®] Compact Hysteroscopes 26252 BB/BC/BH in combination with HAMOU[®] ENDOMAT[®] 26 3310 20 and/or HYSTEROMAT E.A.S.I.[®] SCB



031317-10

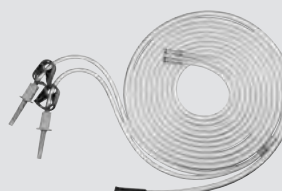

031417-10

- 031317-10 **Tubing Set**, with Monobloc connector and irrigation and suction tube, sterile, for single use, package of 10, for use with B.I.O.H.[®] Compact Hysteroscopes 26252 BB/BC/BH in combination with HAMOU[®] ENDOMAT[®] 26 3310 20 (connection to pump only with Pump Tubing Day Set 031167-10)
- 031417-10 **Tubing Set**, with Monobloc connection and irrigation and suction tube, with two puncture needles, sterile, for single use, package of 10, for use with B.I.O.H.[®] Compact Hysteroscopes 26252 BB/BH

Tubing Sets

for irrigation and suction



Special Features:

- Optical product matching thanks to clear color coding (red and blue)



For use with HYSTEROMAT E.A.S.I.® SCB

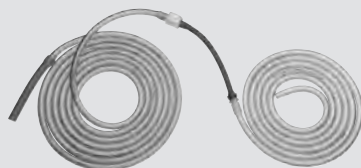

031217-10



031717-10

- 031217-10 **Tubing Set for Suction**, sterile, for single use, package of 10, for use with HYSTEROMAT E.A.S.I.® SCB and UROMAT E.A.S.I.® SCB
- 031717-10 **Tubing Set for Irrigation**, with two puncture cannulas, sterile, for single use, package of 10, for use with HYSTEROMAT E.A.S.I.® SCB and UROMAT E.A.S.I.® SCB

Tubing Sets

Pump Tubing Day Set and Patient Tube



Special Features:

- Optical product matching thanks to clear color coding (red and blue)

For use with HYSTEROMAT E.A.S.I.® SCB



031767-10

STERILE

031767-10 **Pump Tubing Day Set**, with two puncture cannulas, sterile, package of 10, for use with HYSTEROMAT E.A.S.I.® SCB and UROMAT E.A.S.I.® SCB in combination with Patient Tubes 031162-10 and 031262-10

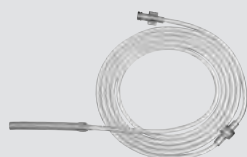

031162-10



031262-10

STERILE

031162-10 **Patient Tube**, sterile, for single use, package of 10, for use with Pump Tubing Day Set 031161-10, 031167-10, 031168-10, 031261-10 and 031767-10

031262-10 **Tubing Set**, with Monobloc connector, sterile, for single use, package of 10, for use with B.I.O.H.® Compact Hysteroscopes 26252 BB/BC/BH in combination with HYSTEROMAT E.A.S.I.® SCB (for use with Tubing Day Sets 031267-01, 031767-01)

Tubing Sets

for suction



Special Features:

- Optical product matching thanks to clear color coding (red and blue)

For use with HYSTEROMAT E.A.S.I.® SCB



031267-10



031267-10 **Tubing Set**, day set for suction, unsterile, package of 10, for use with HYSTEROMAT E.A.S.I.® SCB (for use with Tubing Set 031262-10)

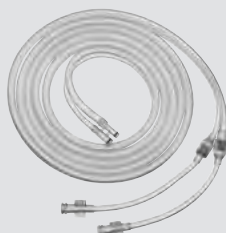

031262-10



031262-10 **Tubing Set**, with Monobloc connector, sterile, for single use, package of 10, for use with B.I.O.H.® Compact Hysteroscopes 26252 BB/BC/BH in combination with HYSTEROMAT E.A.S.I.® SCB (for use with Tubing Day Sets 031267-01, 031767-01)

Tubing Sets

for irrigation and suction



Special Features:

- No risk of confusion when placing the connectors
- Automatic product recognition and mode selection via the pump



For use with ENDOMAT® SELECT



031523-10



030647-10

031523-10 **Tubing Set for Irrigation**, PC, sterile, for single use, package of 10, for use with HAMOU® ENDOMAT® SCB 26 3311 20-1 and ENDOMAT® SELECT

030647-10 **Tubing Set for Suction**, DS, sterile, for single use, package of 10, for use with ENDOMAT® SELECT

Tubing Sets

for irrigation and suction



Special Features:

- No risk of confusion when placing the connectors

For use with HAMOU® ENDOMAT®SCB 26 3311 20-1



031523-10



031523-10 **Tubing Set for Irrigation, PC, sterile, for single use, package of 10, for use with HAMOU® ENDOMAT® SCB 26 3311 20-1 and ENDOMAT® SELECT**



030547-01



030547-01 **Tubing Set for Suction, 150 cm, with EXTRA-LARGE LUER-Lock, unsterile, for use with HAMOU® ENDOMAT® SCB 26 3311 20-1**

Tubing Sets

Irrigation Tubing Set



Special Features:

- Optical product matching thanks to clear color coding (blue)
- Automatic product recognition and mode selection via the pump (HYS mode)

STERILE 

For use with HAMOU® ENDOMAT® 26 3310 20 for hysteroscopy and HYSTEROMAT® II

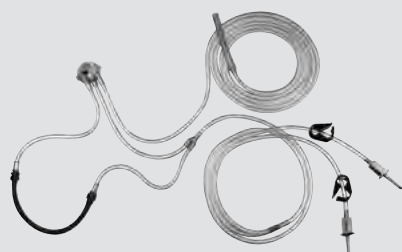

031117-10



031140-10

- 031117-10 **Tubing Set for Irrigation**, with two puncture cannulas, sterile, for single use, package of 10, for use with HAMOU® ENDOMAT® 26 3310 20, for hysteroscopy and HYSTEROMAT® II
- 031140-10 **Tubing Set**, with two Care-Lock connectors, sterile, for single use, package of 10, for use with HAMOU® ENDOMAT® 26 3310 20, for hysteroscopy and HYSTEROMAT® II

Tubing Sets

Pump Tubing Day Set and Patient Tube



Special Features:

- Optical product matching thanks to clear color coding (blue)
- Automatic product recognition and mode selection via the pump (HYS mode)

For use with HAMOU® ENDOMAT® 26 3310 20 for hysteroscopy and HYSTEROMAT® II

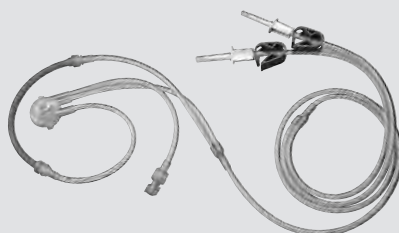

031167-10

STERILE

031167-10 **Pump Tubing Day Set**, with two puncture cannulas, sterile, package of 10, for use with HAMOU® ENDOMAT® 26 3310 20, for hysteroscopy and HYSTEROMAT® II, in combination with Patient Tube 031162-10

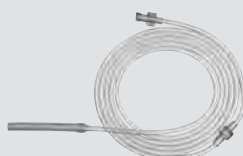

031162-10

STERILE

031162-10 **Patient Tube**, sterile, for single use, package of 10, for use with Pump Tubing Day Set 031161-10, 031167-10, 031168-10, 031261-10 and 031767-10

Spare Parts and Accessories

Sealing Cap "Endoscopic Seal"



The endoscopic seal for the working channel of an endoscope is designed to minimize the leakage of fluid or gas. Due to the removable LUER-Lock male connector,

the endoscopic seal is compatible with both a LUER-Lock female connector and an olive connector.

Special Features:

- For instruments and catheters with 3 – 7 Fr. or 4 – 10 Fr.
- Double sealing technology for maximum tightness
- For LUER-Lock and olive connectors
- Funnel-shaped for easier insertion of instruments
- For gynecology, urology and proctology



100010-10 **Sealing Cap "Endoscopic Seal"**, sterile, for single use, for working channels of 3 – 7 Fr. instruments, package of 10



100020-10 **Sealing Cap "Endoscopic Seal"**, sterile, for single use, for working channels of 4 – 10 Fr. instruments, package of 10



UROLOGY

UNIPOLAR ELECTRODES FOR
RESECTOSCOPE SYSTEMS 142-146

BIPOLAR ELECTRODES FOR
RESECTOSCOPE SYSTEMS 147-150

LASER FIBERS,
URETHROTOME KNIVES 151-152

INSTRUMENTS FOR
PEDIATRICS 153

BOUGIES AND CATHETERS,
GUIDE WIRES, CYTOLOGY BRUSHES,
STONE BASKETS 154-156

TUBING SETS 157-163

SPARE PARTS AND
ACCESSORIES 164

Unipolar Electrodes for Resectoscope Systems



Special Features:

- Easy product matching thanks to white color coding for 19/22 Fr.
- Single-use product guarantees functionality

STERILE

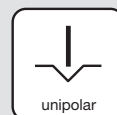

For use with 22 Fr. Resectoscope Sheaths



011220-10



011220-10

Unipolar Cutting Loop, angled, 1 guide rod, 22 Fr., sterile, for single use, package of 10, for use with Working Elements 26055 E and 27054 E, color code: white

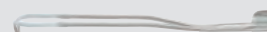

011223-10

Unipolar Coagulation Electrode, pointed, 1 guide rod, 22 Fr., sterile, for single use, package of 10, for use with Working Elements 26055 E and 27054 E, color code: white

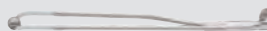

011224-10

Unipolar Coagulation Electrode, ball end, diameter 3 mm, 1 guide rod, 22 Fr., sterile, for single use, package of 10, for use with Working Elements 26055 E and 27054 E, color code: white

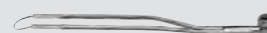

011222-10

Unipolar Cutting Loop, angled 25°, 1 guide rod, 22 Fr., sterile, for single use, package of 10, for use with Working Elements 26055 E and 27054 E, color code: white

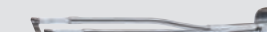

011221-10

Unipolar VAPORCUT® Electrode, band width 1.2 mm, 1 guide rod, 22 Fr., sterile, for single use, package of 10, for use with Working Elements 26055 E and 27054 E, color code: white

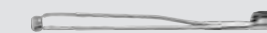

011225-10

Unipolar Roller Electrode, cylindrical, 1 guide wire, 22 Fr., sterile, for single use, package of 10, for use with Working Elements 26055 E and 27054 E, color code: white

Unipolar Electrodes for Resectoscope Systems



Special Features:

- Easy product matching thanks to yellow and brown color coding for 24/26 Fr. and/or 27/28 Fr.
- Single-use product guarantees functionality

STERILE



For use with 24/26 Fr. and/or 27/28 Fr. Resectoscope Sheaths



011110-10



- 011110-10 **Unipolar Cutting Loop**, angled, 1 guide rod, 24/26 Fr., sterile, for single use, package of 10, for use with Working Elements 26050 D/E and 27050 C/D/E, color code: yellow
- 011210-10 **Same**, 27/28 Fr., for use with Working Elements 27050 C/D/E, color code: brown



- 011111-10 **Unipolar Coagulation Electrode**, pointed, 1 guide rod, 24/26 Fr., sterile, for single use, package of 10, for use with Working Elements 26050 D/E and 27050 C/D/E, color code: yellow
- 011211-10 **Same**, 27/28 Fr., for use with Working Elements 27050 C/D/E, color code: brown



- 011112-10 **Unipolar Coagulation Electrode**, ball end, diameter 3 mm, 1 guide rod, 24/26 Fr., sterile, for single use, package of 10, for use with Working Elements 26050 D/E and 27050 C/D/E, color code: yellow
- 011212-10 **Same**, 27/28 Fr., for use with Working Elements 27050 C/D/E, color code: brown

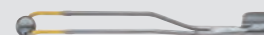

- 011113-10 **Unipolar Coagulation Electrode**, ball end, diameter 5 mm, 1 guide rod, 24/26 Fr., sterile, for single use, package of 10, for use with Working Elements 26050 D/E and 27050 C/D/E, color code: yellow
- 011213-10 **Same**, 27/28 Fr., for use with Working Elements 27050 C/D/E, color code: brown



Special Features:

- Easy product matching thanks to yellow color coding for 24/26 Fr.
- Single-use product guarantees functionality

STERILE



For use with 24/26 Fr. Resectoscope Sheaths



011110-10



011118-10 **Unipolar Cutting Loop**, longitudinal, 1 guide rod, 24/26 Fr., sterile, for single use, package of 10, for use with Working Elements 26050 D/E and 27050 C/D/E, color code: yellow

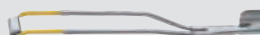

011119-10 **Unipolar Coagulation Electrode**, cylindrical, diameter 3 mm, 1 guide rod, 24/26 Fr., sterile, for single use, package of 10, for use with Working Elements 26050 D/E and 27050 C/D/E, color code: yellow



011120-10 **Unipolar Coagulation Electrode**, cylindrical, diameter 5 mm, 1 guide rod, 24/26 Fr., sterile, for single use, package of 10, for use with Working Elements 26050 D/E and 27050 C/D/E, color code: yellow



011121-10 **Unipolar VAPORCUT® Electrode**, band width 1.2 mm, 1 guide rod, 24/26 Fr., sterile, for single use, package of 10, for use with Working Elements 26050 D/E and 27050 C/D/E, color code: yellow

Unipolar Electrodes for Resectoscope Systems



Special Features:

- Easy product matching thanks to yellow color coding for 24/26 Fr.
- Single-use product guarantees functionality

STERILE



For use with 24/26 Fr. Resectoscope Sheaths



011114-10



011114-10

Unipolar Cutting Loop, angled, 2 guide rods, 24/26 Fr., sterile, for single use, package of 10, for use with Working Elements 27040 C/D/E, color code: yellow



011115-10

Unipolar Coagulation Electrode, pointed, 2 guide rods, 24/26 Fr., sterile, for single use, package of 10, for use with Working Elements 27040 C/D/E, color code: yellow



011116-10

Unipolar Coagulation Electrode, ball end, diameter 3 mm, 2 guide rods, 24/26 Fr., sterile, for single use, package of 10, for use with Working Elements 27040 C/D/E, color code: yellow



011117-10

Unipolar Coagulation Electrode, ball end, diameter 5 mm, 2 guide rods, 24/26 Fr., sterile, for single use, package of 10, for use with Working Elements 27040 C/D/E, color code: yellow

Extra-long Unipolar Electrodes for Resectoscope Systems



Special Features:

- Easy product matching thanks to yellow-blue color coding for 24/26 Fr.
- Single-use product guarantees functionality

STERILE



For use with 24/26 Fr. Resectoscope Sheaths

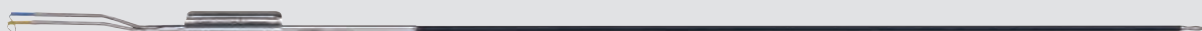

011240-10



011240-10

Unipolar Cutting Loop, angled, 1 guide rod, 24/26 Fr., sterile, for single use, package of 10, for use with Working Elements 27050 DP/EP, color code: yellow-blue



011241-10

Unipolar Coagulation Electrode, pointed, 1 guide rod, 24/26 Fr., sterile, for single use, package of 10, for use with Working Elements 27050 DP/EP, color code: yellow-blue

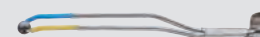

011242-10

Unipolar Coagulation Electrode, ball end, diameter 3 mm, 1 guide rod, 24/26 Fr., sterile, for single use, package of 10, for use with Working Elements 27050 DP/EP, color code: yellow-blue

Bipolar Electrodes for Resectoscope Systems



Special Features:

- Easy product matching thanks to white color coding for 22 Fr.
- Single-use product guarantees functionality

STERILE

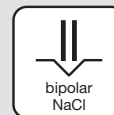

For use with 22 Fr. Resectoscope Sheaths



011250-10



011250-10

Bipolar Cutting Loop, 2 guide rods, 22 Fr., sterile, for single use, package of 10, for use with Working Elements 26055 EB and 27054 EB, color code: white



011251-10

Bipolar Coagulation Electrode, pointed, 2 guide rods, 22 Fr., sterile, for single use, package of 10, for use with Working Elements 26055 EB and 27054 EB, color code: white



011252-10

Bipolar Coagulation Electrode, ball end, 2 guide rods, 22 Fr., sterile, for single use, package of 10, for use with Working Elements 26055 EB and 27054 EB, color code: white



Special Features:

- Easy product matching thanks to yellow or yellow-orange color coding for 24/26 Fr.
- Universally usable for 12° and 30° telescopes
- Single-use product guarantees functionality

STERILE

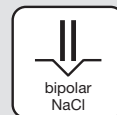

For use with 24/26 Fr. Resectoscope Sheaths

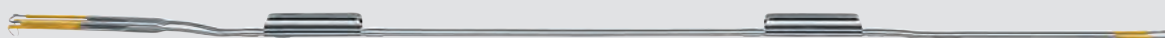

011160-10



011160-10

Bipolar Cutting Loop, 2 guide rods, 24/26 Fr., sterile, for single use, package of 10, for use with Working Elements 26040 DB/EB and 27040 DB/EB as well as 12° Telescopes 26105 FA/27005 FA and 30° Telescopes 26105 BA/27005 BA, color code: yellow



011161-10

Bipolar Cutting Loop, small, 2 guide rods, 24/26 Fr., sterile, for single use, package of 10, for use with Working Elements 26040 DB/EB and 27040 DB/EB as well as 12° Telescopes 26105 FA/27005 FA and 30° Telescopes 26105 BA/27005 BA, color code: yellow



011162-10

Bipolar Cutting Loop, longitudinal, 2 guide rods, 24/26 Fr., sterile, for single use, package of 10, for use with Working Elements 26040 DB/EB and 27040 DB/EB as well as 12° Telescopes 26105 FA/27005 FA and 30° Telescopes 26105 BA/27005 BA, color code: yellow-orange



011163-10

Bipolar Coagulation Electrode, pointed, 2 guide rods, 24/26 Fr., sterile, for single use, package of 10, for use with Working Elements 26040 DB/EB and 27040 DB/EB as well as 12° Telescopes 26105 FA/27005 FA and 30° Telescopes 26105 BA/27005 BA, color code: yellow



011156-10

Bipolar Coagulation Electrode, ball end, 2 guide rods, 24/26 Fr., sterile, for single use, package of 10, for use with Working Elements 26040 DB/EB and 27040 DB/EB as well as 12° Telescopes 26105 FA/27005 FA and 30° Telescopes 26105 BA/27005 BA, color code: yellow

Bipolar Electrodes for Resectoscope Systems



STERILE

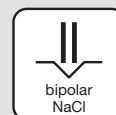

Special Features:

- Easy product matching thanks to yellow or yellow-orange color coding for 24/26 Fr.
- Universally usable for 12° and 30° telescopes
- Single-use product guarantees functionality

For use with 24/26 Fr. Resectoscope Sheaths



011167-10



011165-10

Bipolar Cutting Loop, diameter 0.30 mm, 2 guide rods, 24/26 Fr., sterile, for single use, package of 10, for use with Working Elements 27040 DB/EB, color code: yellow-orange



011166-10

Bipolar Cutting Loop, rectangular, longitudinal, diameter 0.30 mm, 2 guide rods, 24/26 Fr., sterile, for single use, package of 10, for use with Working Elements 27040 DB/EB, color code: yellow-orange



011167-10

Bipolar Cutting Loop, longitudinal, diameter 0.30 mm, 2 guide rods, 24/26 Fr., sterile, for single use, package of 10, for use with Working Elements 27040 DB/EB, color code: yellow-orange



011168-10

Bipolar Cutting Loop, diameter 0.40 mm, 2 guide rods, 24/26 Fr., sterile, for single use, package of 10, for use with Working Elements 27040 DB/EB, color code: yellow



011169-10

Bipolar VapoEnucleation Electrode, hemispherical, 2 guide rods, 24/26 Fr., sterile, for single use, package of 10, for use with Working Elements 27040 DB/EB, color code: yellow

Extra-long Bipolar Electrodes for Resectoscope Systems



Special Features:

- Easy product matching thanks to yellow color coding for 24/26 Fr.
- Single-use product guarantees functionality

STERILE

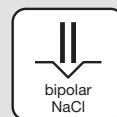

For use with 24/26 Fr. Resectoscope Sheaths



011180-10



011180-10

Bipolar Cutting Loop, extra-long, 2 guide rods, 24/26 Fr., sterile, for single use, package of 10, for use with Working Elements 27040 DO/EO, color code: yellow



011181-10

Bipolar Coagulation Electrode, extra-long, pointed, 2 guide rods, 24/26 Fr., sterile, for single use, package of 10, for use with Working Elements 27040 DO/EO, color code: yellow



011182-10

Bipolar Vaporization Electrode, HALF MOON®, extra-long, ball end, 2 guide rods, 24/26 Fr., sterile, for single use, package of 10, for use with Working Elements 27040 DO/EO, color code: yellow



For use with CALCULASE II

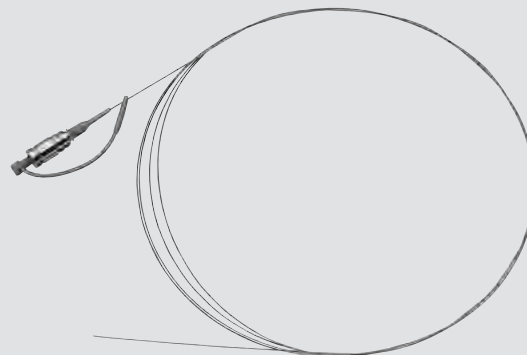

27 7502 77

27 7502 77-P6 CALCULASE II Fiber 230 μm , length 300 cm, sterile, for single use, package of 6

27 7502 78-P6 CALCULASE II Fiber 365 μm , length 300 cm, sterile, for single use, package of 6

27 7502 79-P6 CALCULASE II Fiber 600 μm , length 300 cm, sterile, for single use, package of 6

27 7502 86 CALCULASE II Fiber Kit

including:

3x **CALCULASE II Fiber 230 μm** , sterile, for single use

3x **CALCULASE II Fiber 365 μm** , sterile, for single use

3x **CALCULASE II Fiber 600 μm** , sterile, for single use

Urethrotome Knives for Optical Urethrotome Systems



Special Features:

- Perfect cutting thanks to single-use product
- Excellent hygienic safety



For use with Working Elements 27040 E, 27050 E and 0° Telescope 27005 AA

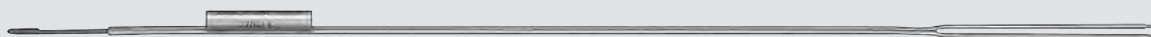

091210-10



091210-10 SACHSE **Urethrotome Knife**, straight, 2 guide rods, sterile, for single use, package of 10, for use with Working Element 27040 E and 0° Telescope 27005 AA

091220-10 SACHSE **Urethrotome Knife**, straight, 1 guide rod, sterile, for single use, package of 10, for use with Working Element 27050 E and 0° Telescope 27005 AA



091211-10 **Urethrotome Knife**, round, 2 guide rods, sterile, for single use, package of 10, for use with Working Element 27040 E and 0° Telescope 27005 AA

091221-10 **Urethrotome Knife**, round, 1 guide rod, sterile, for single use, package of 10, for use with Working Element 27050 E and 0° Telescope 27005 AA

The knives are not to be used with HF current!



For use with Cysto-Urethroscope 27030 KA/KB for children

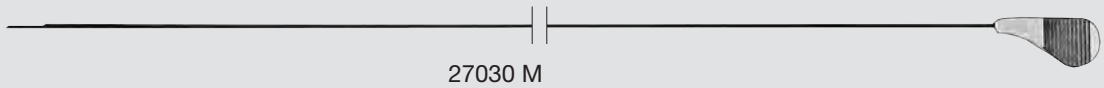

27030 M



27030 M

Knife, triangular tip, 3 Fr., for single use, package of 6



27030 N



27030 N

Injection Needle, rigid, 3 Fr., for single use, package of 6



27030 EL



27030 EL

Hook Electrode, unipolar, 3 Fr., for single use, package of 6



27576 B – F

27577 A – G

FILIFORM Bougies
for use with PHILIPS Catheter 27577

- 27576 B 3 Fr.
- 27576 C 4 Fr.
- 27576 D 5 Fr.
- 27576 E 6 Fr.
- 27576 F 7 Fr.

PHILIPS Catheter
for use with FILIFORM Bougies 27576

- 27577 A 8 Fr.
- 27577 B 10 Fr.
- 27577 C 12 Fr.
- 27577 D 14 Fr.
- 27577 E 16 Fr.
- 27577 F 18 Fr.
- 27577 G 20 Fr.



27023 WU

Balloon Catheter, sterile, for single use,
3 Fr.

Guide Wires, Brushes



For use with flexible Uretero-Reno-Fiberscopes 11278 A/AU and flexible Video Uretero-Renosscopes 11278 VS/VSU/VVU

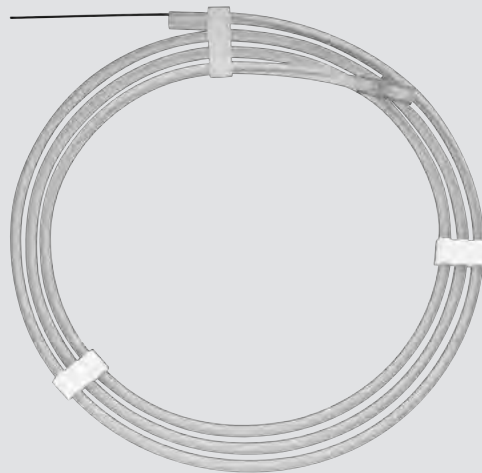

27025 P

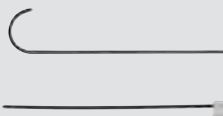

27091 S

Guide Wire, for introduction through the Cannulas 27091 K/A, package of 2

27025 P

Guide Wire, with ball end, 3 Fr., sterile, package of 10

For use with 27000 L/K and 27001 L/K



27023 Y

Cytology Brush, 3 Fr., unsterile, for single use, package of 5

Stone Baskets



For use with Uretero-Renoscopes and Cysto-Urethrosopes

STERILE

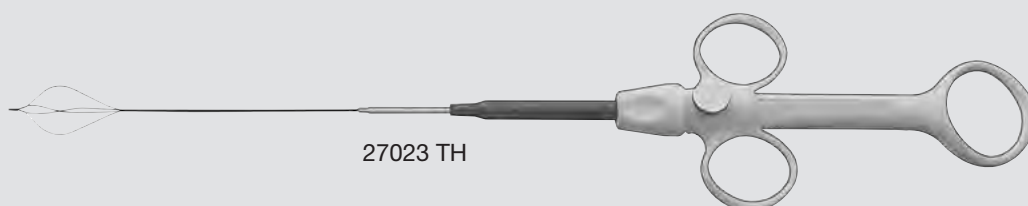

27023 TH

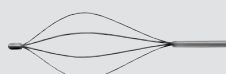

27023 TH

Stone Basket, nitinol, with tip, straight, 5 Fr., length 90 cm, 4 wires, basket diameter 16 mm, sterile, for single use



27023 TD

Stone Basket, nitinol, with tip, helical, 2.5 Fr., length 120 cm, 4 wires, basket diameter 16 mm, sterile, for single use

27023 TF

Stone Basket, nitinol, with tip, helical, 3 Fr., length 120 cm, 4 wires, basket diameter 16 mm, sterile, for single use



27023 LD

Stone Basket, nitinol, without tip, straight, 2.5 Fr., length 120 cm, 4 wires, basket diameter 16 mm, sterile, for single use, package of 3

27023 KF

Stone Basket, nitinol, without tip, straight, 3 Fr., length 70 cm, 4 wires, basket diameter 12 mm, sterile, for single use

27023 LF

Stone Basket, nitinol, without tip, straight, 3 Fr., length 120 cm, 4 wires, basket diameter 12 mm, sterile, for single use

27023 LB

Stone Basket, nitinol, without tip, straight, 1.9 Fr., length 120 cm, 4 wires, basket diameter 12 mm, sterile, for single use

Tubing Sets

for irrigation and suction



Special Features:

- Optical product matching thanks to clear color coding (red and blue)



For use with UROMAT E.A.S.I.® SCB

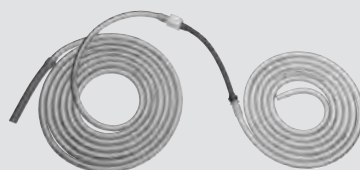

031217-10



031717-10

- 031217-10 **Tubing Set for Suction**, sterile, for single use, package of 10, for use with HYSTEROMAT E.A.S.I.® SCB and UROMAT E.A.S.I.® SCB
- 031717-10 **Tubing Set for Irrigation**, with two puncture cannulas, sterile, for single use, package of 10, for use with HYSTEROMAT E.A.S.I.® SCB and UROMAT E.A.S.I.® SCB

Tubing Sets

Pump Tubing Day Set and Patient Tube



Special Features:

- Optical product matching thanks to clear color coding (red and blue)

For use with HYSTEROMAT E.A.S.I.® SCB



031767-10

STERILE

031767-10 **Pump Tubing Day Set**, with two puncture cannulas, sterile, package of 10, for use with HYSTEROMAT E.A.S.I.® SCB and UROMAT E.A.S.I.® SCB in combination with Patient Tubes 031162-10 and 031262-10



031162-10

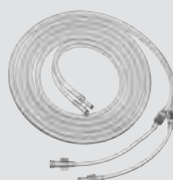

031262-10

STERILE

031162-10 **Patient Tube**, sterile, for single use, package of 10, for use with Pump Tubing Day Set 031161-10, 031167-10, 031168-10, 031261-10 and 031767-10

031262-10 **Tubing Set**, with Monobloc connector, sterile, for single use, package of 10, for use with B.I.O.H.® Compact Hysteroscopes 26252 BB/BC/BH in combination with HYSTEROMAT E.A.S.I.® SCB (for use with Tubing Day Sets 031267-01, 031767-01)

Tubing Sets

for irrigation and suction



Special Features:

- No risk of confusion when placing the connectors
- Automatic product recognition and mode selection via the pump



For use with ENDOMAT® SELECT



031523-10



030647-10



031647-10

- 031523-10 **Tubing Set for Irrigation, PC, sterile, for single use, package of 10, for use with HAMOU® ENDOMAT® SCB 26 3311 20-1 and ENDOMAT® SELECT**
- 030647-10 **Tubing Set for Suction, DS, sterile, for single use, package of 10, for use with ENDOMAT® SELECT**
- 031647-10 **Tubing Set for Suction, BS, sterile, for single use, package of 10, for use with ENDOMAT® SELECT**

Tubing Sets

Irrigation Tubing Sets



Special Features:

- Optical product matching thanks to clear color coding (white)



For use with UROMAT and UROPUMP

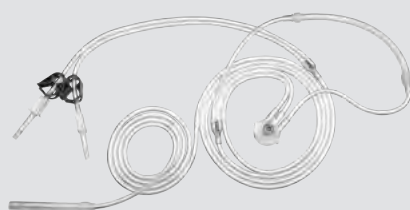

031128-10

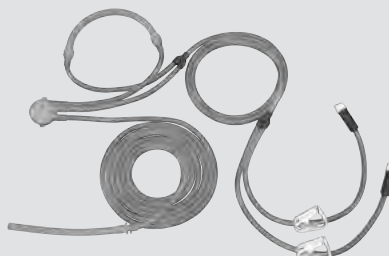

031142-10

031128-10 **Tubing Set**, with two puncture cannulas, sterile, for single use, package of 10, for use with ARTHROPUMP® SCB, ARTHROPUMP® plus, UROMAT and UROPUMP

031142-10 **Tubing Set**, with two Care-Lock connectors, sterile, for single use, package of 10, for use with ARTHROPUMP® SCB, ARTHROPUMP® plus, UROMAT and UROPUMP

Tubing Sets

Pump Tubing Day Set and Patient Tube



Special Features:

- Optical product matching thanks to clear color coding (white)

For use with UROMAT and UROPUMP

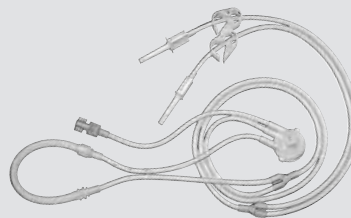

031161-10

STERILE

031161-10 **Pump Tubing Day Set**, with two puncture cannulas, sterile, package of 10, for use with ARTHROPUMP® SCB, ARTHROPUMP® plus, UROMAT and UROPUMP in combination with Patient Tube 031162-10



031162-10

STERILE

031162-10 **Patient Tube**, sterile, for single use, package of 10, for use with Pump Tubing Day Set 031161-10, 031167-10, 031168-10, 031261-10 and 031767-10

Tubing Sets

for suction



For use with S-PILOT®

STERILE 



031457-10

031457-10 **Tubing Set for Suction**, sterile, for single use, package of 10, for use with S-PILOT®, for urology/gynecology

Tubing Sets

for suction



For use with UROMAT and CALCUSON

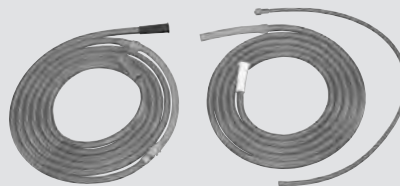

031347-10

031347-10 **Tubing Set for Suction**, sterile, for single use, package of 10, for use with UROMAT and CALCUSON

Spare Parts and Accessories

Sealing Cap "Endoscopic Seal"



The endoscopic seal for the working channel of an endoscope is designed to minimize the leakage of fluid or gas. Due to the removable LUER-Lock male connector,

the endoscopic seal is compatible with both a LUER-Lock female connector and an olive connector.



Special Features:

- For instruments and catheters with 3 – 7 Fr. or 4 – 10 Fr.
- Double sealing technology for maximum tightness
- For LUER-Lock and olive connectors
- Funnel-shaped for easier insertion of instruments
- For gynecology, urology and proctology



100010-10 **Sealing Cap "Endoscopic Seal"**, sterile, for single use, for working channels of 3 – 7 Fr. instruments, package of 10



100020-10 **Sealing Cap "Endoscopic Seal"**, sterile, for single use, for working channels of 4 – 10 Fr. instruments, package of 10



PROCTOLOGY

RUBBER LIGATURE RINGS 166

POLYPECTOMY SNARES 167

GAS FILTER FOR RECTOVISION® 168

TUBING SETS 169

SPARE PARTS AND
ACCESSORIES 170

Rubber Ligature Rings



25210 R

- 25210 R **Rubber Ligature Ring**, containing latex, package of 100
- 25210 RP **Rubber Ligature Ring**, extra strong, containing latex, package of 100
- 25210 RL **Rubber Ligature Ring**, latex-free, package of 100



Polypectomy Snares

for Rectoscopy



For use with Snare Guides 25731 and 25732



25233



25233

Wire Snare, for Snare Guides 25731 and 25732,
for single use, package of 25

Gas Filter

for RECTOVISION®



For use with HAMOU® MICRO HYSTEROFLATOR SCB and Rubber Insufflation Bulb 40924



031123-10

031123-10 **Gas Filter**, for fluid irrigation, with male LUER-Lock connector and female LUER-Lock connector, sterile, for single use, package of 10, for use with insufflation units with a maximum gas flow of 1 l/min (HAMOU® MICRO HYSTEROFLATOR SCB)

Tubing Set

Irrigation Tubing Set



Special Features:

- No risk of confusion when placing the connectors
- Automatic product recognition and mode selection via the pump



For use with ENDOMAT® SELECT



031524-10

031524-10 **Tubing Set for Irrigation, FC, sterile, for single use, package of 10, for use with HAMOU® ENDOMAT® SCB 263311 20-1 and ENDOMAT® SELECT**

Spare Parts and Accessories

Brush Inserts and Sealing Cap for
Video-assisted Fistula Therapy



Brush Inserts

For use with Fistula Brush 24514 and Fistulectomy Set 24511

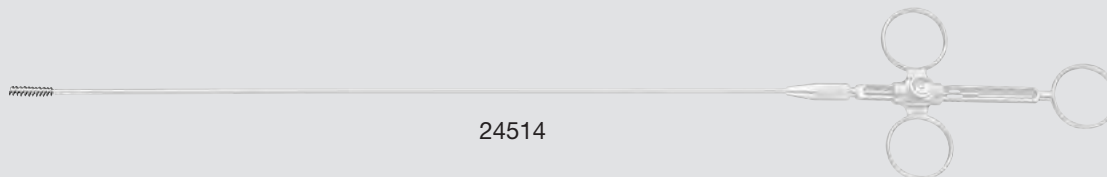

24514



24514 A

Fistula Brush Insert, outer diameter 4 mm

24514 B

Fistula Brush Insert, outer diameter 4.5 mm

24514 C

Fistula Brush Insert, outer diameter 5 mm



Sealing Cap “Endoscopic Seal”

The endoscopic seal for the working channel of an endoscope is designed to minimize the leakage of fluid or gas. Due to the removable LUER-Lock male connector,

the endoscopic seal is compatible with both a LUER-Lock female connector and an olive connector.

Special Features:

- For instruments and catheters with 3 – 7 Fr. or 4 – 10 Fr.
- Double sealing technology for maximum tightness
- For LUER-Lock and olive connectors
- Funnel-shaped for easier insertion of instruments
- For gynecology, urology and proctology



100020-10

Sealing Cap “Endoscopic Seal”, sterile, for single use, for working channels of 4 – 10 Fr. instruments, package of 10



ARTHROSCOPY AND SPORTS MEDICINE

INSTRUMENTS FOR
HARVESTING THE
QUADRICEPS TENDON 172

GUIDE WIRES,
DRILLING AND LARDING WIRES 173-174

PORTAL SYSTEMS FOR
SHOULDER AND HIP
ARTHROSCOPY, ACCESSORIES 175-179

SUTURE CATCHER 180

SHAVER BLADES 181-185

IMPLANTS 186-192

ELECTRODES,
SAW BLADES 193-195

TUBING SETS 196-200

Instruments

for harvesting the quadriceps tendon



For use with Handle 28185 MH



28185 MH

This system was especially developed for harvesting the quadriceps tendon for MPFL reconstruction.

Special Features:

- Safe subcutaneous tendon harvesting
- Defined harvesting depth
- Attractive cosmetic results



28185 FA

28185 FA

Tendon Knife, for removal of quadriceps tendon for MPFL reconstruction, vertical parallel cutting, width 10 mm, height 4 mm, sterile, for single use, for use with Handle 28185 MH

28185 FB

Same, width 12 mm



28185 EA

28185 EA

Tendon Separator, for removal of the quadriceps tendon for MPFL reconstruction, horizontal parallel cutting, height 2 mm, sterile, for single use, for use with Handle 28185 MH

28185 EB

Same, height 3 mm

This system was especially developed for harvesting the quadriceps tendon for anterior cruciate ligament reconstruction.

Special Features:

- Safe subcutaneous tendon harvesting
- Harvesting possible with or without bone block
- Defined harvesting depth
- Attractive cosmetic results



28185 FC

28185 FC

Tendon Knife, for removal of the quadriceps tendon for cruciate ligament reconstruction, vertical parallel cutting, width 8 mm, height 6 mm, sterile, for single use, for use with Handle 28185 MH

28185 FD

Same, width 9 mm

28185 FE

Same, width 10 mm

28185 FF

Same, width 12 mm



28185 EC

28185 EC

Tendon Separator, for removal of the quadriceps tendon for cruciate ligament reconstruction, horizontal parallel cutting, height 5 mm, sterile, for single use, for use with Handle 28185 MH

For further information on the implant portfolio see ARTHROSCOPY AND SPORTS MEDICINE catalog



For use with CROSSDRIVE® Screwdrivers 28789 SK, 28770 SK and 28760 SK



28789 SK

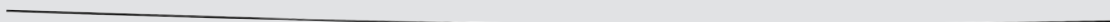

28789 GW

28789 GW-6 **Nitinol Guide Wire**, diameter 1.1 mm, length 38.5 cm, unsterile, for single use, package of 6, for use with CROSSDRIVE® Screwdrivers 28789 SK, 28770 SK and 28760 SK

28789 KW-6 **Nitinol Guide Wire**, diameter 1.1 mm, length 25.5 cm, unsterile, for single use, package of 6, for use with CROSSDRIVE® Screwdrivers 28789 SK, 28770 SK and 28760 SK

For use with CROSSDRIVE® PLUS Screwdriver 28789 CD



28789 CD

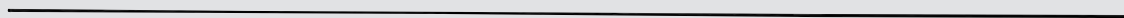

28789 FW

28789 FW-6 **Nitinol Guide Wire**, diameter 2 mm, length 38.5 cm, unsterile, for single use, package of 6, for use with CROSSDRIVE® PLUS Screwdriver 28789 CD

For use with Changing Rod 28140 WK or Puncture Needle 28140 DB



28140 WK

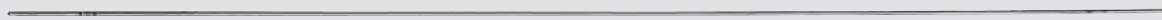

28140 GW-6

28140 GW-6 **Nitinol Guide Wire**, diameter 1.5 mm, length 40 cm, unsterile, for single use, package of 6

For further information on the implant portfolio see ARTHROSCOPY AND SPORTS MEDICINE catalog

Drilling and Larding Wires



For use with Multifunction Handpiece 28 7210 36 and Pin Driver 28 7210 33



28 7210 36



28729 D

28729 D-6 **Drilling Wire**, spiral shape, with eyelet, diameter 2.4 mm, length 38 cm, unsterile, for single use, package of 6, for use with Undercut Drills 28729 BA – BH, Collar Burrs 28729 BLC – BLF and Drills 28729 GA – GE



28729 E

28729 E **Larding Wire**, pyramidal tip, diameter 2.4 mm, length 32 cm, unsterile, for single use, package of 10, for use with Undercut Drills 28729 BA – BH, Collar Burrs BLC – BLF and Drills 28729 GA – GE

For further information on the implant portfolio see ARTHROSCOPY AND SPORTS MEDICINE catalog

Portal Systems

for Shoulder Arthroscopy



For use with Dilator 28180 GO



28180 GO



28180 GT-6

28180 GT-6 **Cannula**, with thread, unsterile, for single use, package of 6, for Gasket 28180 GD, inner diameter 8.25 mm, working length 7 cm, for use with Dilator 28180 GO



28180 GDS

28180 GDS **Seal Set**, with sealing cap, unsterile, for single use, package of 5, for use with Cannula 28180 GT

For further information on the implant portfolio see ARTHROSCOPY AND SPORTS MEDICINE catalog

Portal Systems

for Shoulder Arthroscopy
SPS – Secure Portal System



For use with Obturator 28179 DO

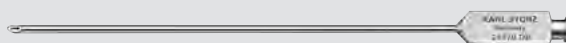

28179 DB

28179 DB **Puncture Needle**, outer diameter 1.4 mm, inner diameter 1 mm, working length 12 cm, unsterile, for single use, for use with Guide Wire 28179 DW and Obturator 28179 DO

For use with Dilator 28179 DL and Handle 28179 DF



28179 DF



28179 DW

28179 DW **Guide Wire**, diameter 0.9 mm, length 30 cm, unsterile, for single use, package of 6

For further information on the implant portfolio see ARTHROSCOPY AND SPORTS MEDICINE catalog

Portal Systems

for Shoulder Arthroscopy
SPS – Secure Portal System



For use with Dilators 28179 EB/EC/FB/FC,
Obturators 28179 EO/EP/FO/FP and Valve Housing 28179 DG
or 28179 OG in combination with Seal Set 28179 GS



28179 EB/EC 28179 EO/EP
28179 FB/FC 28179 FO/FP



28179 SA-6/SB-6
28179 SC-6/SD-6

- 28179 SA-6 **Cannula**, with thread, transparent, unsterile, for single use, package of 6
- 28179 SB-6 **Cannula**, with thread, transparent, unsterile, for single use, package of 6
- 28179 SC-6 **Cannula**, with thread, transparent, unsterile, for single use, package of 6
- 28179 SD-6 **Cannula**, with thread, transparent, unsterile, for single use, package of 6



28179 GS

- 28179 GS **Seal Set**, sterile, for single use, package of 10, for use with Valve Housing 28179 DG/OG

For further information on the implant portfolio see ARTHROSCOPY AND SPORTS MEDICINE catalog

Portal Systems

for Hip Arthroscopy



For use with Dilators 28140 EB/EC/FB/FC,
Obturator 28140 EO/EP/FO/FP and Valve Housing 28179 DG
or 28179 OG in combination with Seal Set 28179 GS



28140 EB/EC 28140 EO/EP
28140 FB/FC 28140 FO/FP



28140 SA-6/SB-6
28140 SC-6/SD-6

- 28140 SA-6 **Cannula**, with thread, transparent, unsterile, for single use, package of 6
- 28140 SB-6 **Cannula**, with thread, transparent, unsterile, for single use, package of 6
- 28140 SC-6 **Cannula**, with thread, transparent, unsterile, for single use, package of 6
- 28140 SD-6 **Cannula**, with thread, transparent, unsterile, for single use, package of 6



28179 GS

- 28179 GS **Seal Set**, sterile, for single use, package of 10, for use with Valve Housing 28179 DG/OG

For further information on the implant portfolio see ARTHROSCOPY AND SPORTS MEDICINE catalog

Accessories for Arthroscopy Sheaths



For use with Arthroscopy Sheaths and Gasket Attachment 28140 D



28140 D



28140 GU

28140 GU

Gasket, unsterile, for single use, package of 10, single-packaged, for use with Gasket Attachment 28140 D



For further information on the implant portfolio see ARTHROSCOPY AND SPORTS MEDICINE catalog

Suture Catcher



For use with Handle 28179 HG, Wheel Attachment 28179 HR, Wheel 28179 R
as well as Suture Attachments 28179 PA/PB/PC/PD/PE/PF/PG and PH



28179 HG
28179 HR/R



28180 BG



28180 BG

Suture Catcher, with inserter, sterile, for single use, package of 10, for use with Suture Attachments 28179 PA – PH and Handle 28179 HG

For further information on the implant portfolio see ARTHROSCOPY AND SPORTS MEDICINE catalog

Shaver Blades



For use with Shaver Handpiece 28200 DX DRILLCUT-X® ARTHRO in conjunction with UNIDRIVE® S III ARTHRO SCB



28200 DX

Working length 180 mm (recommended for soft tissue)

Type	Sterile, for single use package of 6 		Reusable single-packaged	Color Code
Aggressive Cutter	28208 BKS	Diameter 4.5 mm	–	green
Aggressive Full Radius Resector	28208 DCS	Diameter 4.5 mm	–	blue
Curved Aggressive Full Radius Resector	28208 EHS	Diameter 4.5 mm	–	light green

Working length 180 mm (recommended for bone)

Semi Hooded Barrel Burr	28208 IDS	Diameter 5.5 mm	–	pink
----------------------------	-----------	--------------------	---	------

Shaver Blades



For use with Shaver Handpiece 28200 DX DRILLCUT-X® ARTHRO in conjunction with UNIDRIVE® S III ARTHRO SCB



28200 DX

Working length 120 mm (recommended for soft tissue)

Type		Sterile, for single use package of 6 		Reusable single-packaged		Color Code
	Aggressive Cutter	28205 ABS	Diameter 3.5 mm	28205 AB	Diameter 3.5 mm	green
		28205 ACS	Diameter 4.2 mm	28205 AC	Diameter 4.2 mm	
		28205 ADS	Diameter 5.5 mm	28205 AD	Diameter 5.5 mm	
	Aggressive Cutter	28205 AKS	Diameter 4.5 mm	28205 AK	Diameter 4.5 mm	green
	End Cutter	28205 BCS	Diameter 4.2 mm	28205 BC	Diameter 4.2 mm	red
	Full Radius Resector	28205 CBS	Diameter 3.5 mm	-	-	yellow
		28205 CCS	Diameter 4.2 mm	28205 CC	Diameter 4.2 mm	
		28205 CDS	Diameter 5.5 mm	-	-	
	Full Radius Resector	28205 CKS	Diameter 4.5 mm	28205 CK	Diameter 4.5 mm	yellow

Shaver Blades



For use with Shaver Handpiece 28200 DX DRILLCUT-X® ARTHRO in conjunction with UNIDRIVE® S III ARTHRO SCB



28200 DX

Working length 120 mm (recommended for soft tissue)

Type		Sterile, for single use package of 6 		Reusable single-packaged		Color Code
	Aggressive Full Radius Resector	28205 DBS	Diameter 3.5 mm	28205 DB	Diameter 3.5 mm	blue
		28205 DCS	Diameter 4.2 mm	28205 DC	Diameter 4.2 mm	
		28205 DDS	Diameter 5.5 mm	28205 DD	Diameter 5.5 mm	
	Aggressive Full Radius Resector	28205 DKS	Diameter 4.5 mm	28205 DK	Diameter 4.5 mm	blue
	Curved Full Radius Resector	28205 EGS	Diameter 4.2 mm	-	-	light blue
	Curved Aggressive Full Radius Resector	28205 EHS	Diameter 4.2 mm	-	-	light green

Working length 120 mm (recommended for soft tissue and bone)

	Pro Line Shaver Blades	28205 MKS	Diameter 4.5 mm	28205 MK	Diameter 4.5 mm	pink
		28205 MDS	Diameter 5.5 mm	-	-	
	Aggressive Pro Line Shaver Blades	28205 NKS	Diameter 4.5 mm	28205 NK	Diameter 4.5 mm	light blue
		28205 NDS	Diameter 5.5 mm	-	-	

Shaver Blades





For use with Shaver Handpiece 28200 DX DRILLCUT-X® ARTHRO in conjunction with UNIDRIVE® S III ARTHRO SCB



28200 DX

Working length 70 mm (recommended for soft tissue)

Type	Sterile, for single use package of 6 		Reusable single-packaged		Color Code
 Aggressive Cutter	28206 AAS	Diameter 2.5 mm	-	-	green
	28206 ABS	Diameter 3.5 mm	-	-	
 Full Radius Resector	28206 CAS	Diameter 2.5 mm	-	-	yellow
	28206 CBS	Diameter 3.5 mm	-	-	
 Aggressive Full Radius Resector	28206 DAS	Diameter 2.5 mm	28206 DA	Diameter 2.5 mm	blue
	28206 DBS	Diameter 3.5 mm	28206 DB	Diameter 3.5 mm	

Working length 70 mm (recommended for bone)

 Small Joint Burr	28206 FAS	Diameter 2.5 mm	-	-	orange
	28206 FBS	Diameter 3.5 mm	-	-	

Shaver Blades



For use with Shaver Handpiece 28200 DX DRILLCUT-X® ARTHRO in conjunction with UNIDRIVE® S III ARTHRO SCB



28200 DX

Working length 120 mm (recommended for bone)

Type		Sterile, for single use package of 6 		Reusable single-packaged		Color Code
	Round Burr	28205 FCS	Diameter 4.2 mm	28205 FC	Diameter 4.2 mm	orange
		28205 FDS	Diameter 5.5 mm	-	-	
	Finish Barrel Burr	28205 GDS	Diameter 4.2 mm	-	-	purple
		28205 GES	Diameter 5.5 mm	28205 GE	Diameter 5.5 mm	
	Aggressive Barrel Burr	28205 HCS	Diameter 4.2 mm	28205 HC	Diameter 4.2 mm	pink
		28205 HDS	Diameter 5.5 mm	28205 HD	Diameter 5.5 mm	
		28205 HES	Diameter 6.5 mm	28205 HE	Diameter 6.5 mm	

Implants

Fixation Buttons



For use with FLIPPTACK Retainer 28729 SC or Inserter 28379 SC



28729 SC

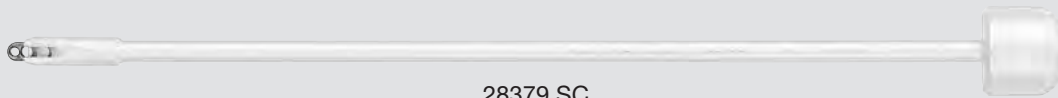

28379 SC



28729 FT

FLIPPTACK, extracortical fixation button, 4 x 12 mm, sterile, for single use

For use with Button Wrench 28729 MS and Positioning Device 28729 ST



28729 TT

ENDOTACK[®], tibial fixation button, 10 x 16 mm, sterile, for single use

For use with Button Wrench 28729 MM and Positioning Device 28729 SM



28729 MT

Mini ENDOTACK[®], tibial fixation button, 8 x 12 mm, sterile, for single use



For use with CROSSDRIVE® Screwdrivers 28789 SK, 28770 SK and 28760 SK



28770 SK

MEGA FIX® B, bioresorbable interference screws, sterile, for single use

	Order No.	Diameter	Length	Instruments
	2870619 B	6 mm	19 mm	28760 SK
	2870623 B	6 mm	23 mm	
	2870719 B	7 mm	19 mm	28770 SK
	2870723 B	7 mm	23 mm	
	2870728 B	7 mm	28 mm	
	2870819 B	8 mm	19 mm	28789 SK
	2870823 B	8 mm	23 mm	
	2870828 B	8 mm	28 mm	
	2870923 B	9 mm	23 mm	
	2870928 B	9 mm	28 mm	

MEGA FIX® P, bioresorbable interference screws, perforated, sterile, for single use

	Order No.	Diameter	Length	Instruments
	2870823 P	8 mm	23 mm	28789 SK
	2870828 P	8 mm	28 mm	
	2870923 P	9 mm	23 mm	
	2870928 P	9 mm	28 mm	
	2870935 P	9 mm	35 mm	
	2871028 P	10 mm	28 mm	
	2871035 P	10 mm	35 mm	
	2871135 P	11 mm	35 mm	



For use with CROSSDRIVE® Screwdrivers 28789 SK, 28770 SK and 28760 SK

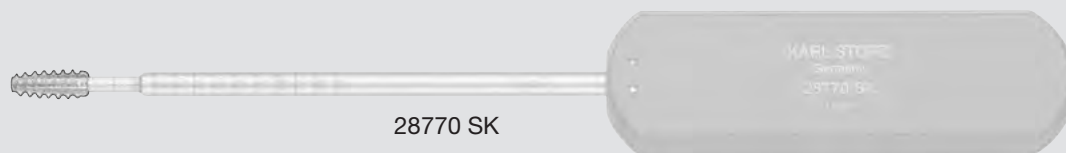

MEGA FIX® C, bioresorbable composite interference screws, sterile, for single use

	Order No.	Diameter	Length	Instruments
	2870619 C	6 mm	19 mm	28760 SK
	2870623 C	6 mm	23 mm	
	2870719 C	7 mm	19 mm	28770 SK
	2870723 C	7 mm	23 mm	
	2870728 C	7 mm	28 mm	
	2870819 C	8 mm	19 mm	28789 SK
	2870823 C	8 mm	23 mm	
	2870828 C	8 mm	28 mm	
	2870923 C	9 mm	23 mm	
	2870928 C	9 mm	28 mm	

MEGA FIX® CP, bioresorbable composite interference screws, perforated, sterile, for single use

	Order No.	Diameter	Length	Instruments
	2870823 CP	8 mm	23 mm	28789 SK
	2870828 CP	8 mm	28 mm	
	2870923 CP	9 mm	23 mm	
	2870928 CP	9 mm	28 mm	
	2870935 CP	9 mm	35 mm	
	2871028 CP	10 mm	28 mm	
	2871035 CP	10 mm	35 mm	
	2871135 CP	11 mm	35 mm	



For use with CROSSDRIVE® PLUS Screwdriver 28789 CD

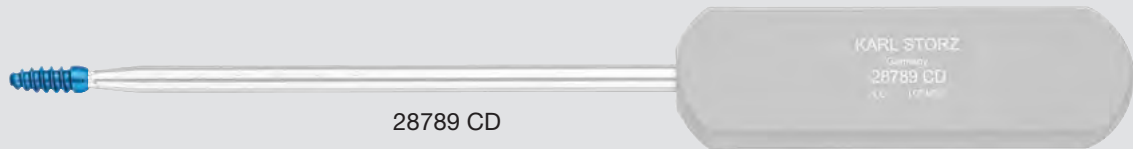

28789 CD

MEGA FIX® T, titanium interference screw, for cruciate ligament reconstruction with bone-tendon-bone transplant, sterile, for single use

	Order No.	Diameter	Length	Instruments
	2870720 T	7 mm	20 mm	28789 CD
	2870725 T	7 mm	25 mm	
	2870820 T	8 mm	20 mm	
	2870825 T	8 mm	25 mm	
	2870920 T	9 mm	20 mm	
	2870925 T	9 mm	25 mm	

MEGA FIX® T, titanium interference screw, for cruciate ligament reconstruction with semitendinosus transplant, sterile, for single use

	Order No.	Diameter	Length	Instruments
	2870723 T	7 mm	23 mm	28789 CD
	2870728 T	7 mm	28 mm	
	2870823 T	8 mm	23 mm	
	2870828 T	8 mm	28 mm	
	2870923 T	9 mm	23 mm	
	2870928 T	9 mm	28 mm	
	2871023 T	10 mm	23 mm	



For use with Applicators 28767 E and 28789 EK

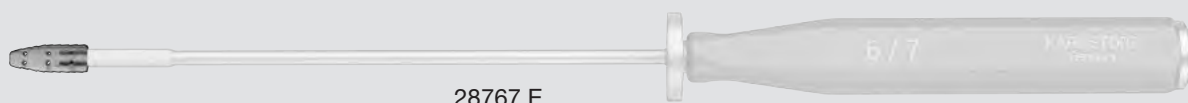

28767 E

MEGASHIM, bioresorbable oval wedge, perforated, sterile, for single use

	Order No.	Size (width x length)	Height	Instruments
	2870620 MSP	6 x 20 mm	4 mm	Dilator 28728 DS Applicator 28767 E Pusher 28767 C HALF PIPE® 28728 SH
	2870720 MSP	7 x 20 mm	4.5 mm	
	2870820 MSP	8 x 20 mm	5 mm	Dilator 28728 DL Applicator 28789 EK Pusher 28789 C HALF PIPE® 28728 SH
	2870920 MSP	9 x 20 mm	5.5 mm	

Implants

Suture Anchors – Titanium



STERILE

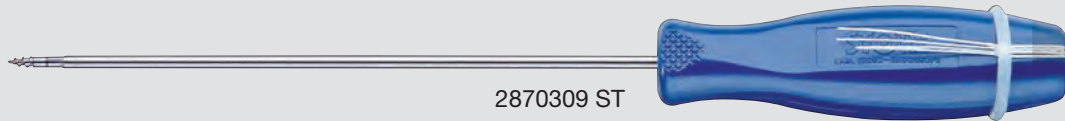

2870309 ST



2870309 ST **Titanium Suture Anchor**, diameter 3 mm, length 9 mm, with two MEGAFIBRE® threads USP 2, pre-assembled, self-tapping, with inserter, sterile, for single use

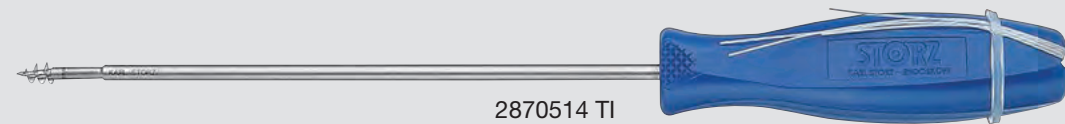

2870514 TI

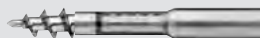

2870514 TI **Titanium Suture Anchor**, diameter 5 mm, length 12.5 mm, with two MEGAFIBRE® threads USP 2, pre-assembled, self-tapping, with inserter, sterile, for single use

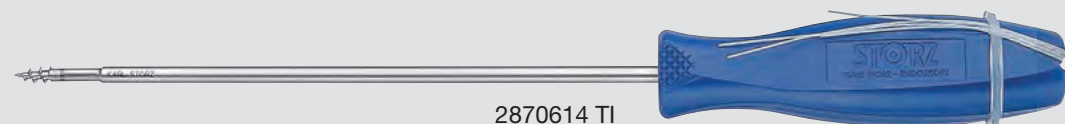

2870614 TI



2870614 TI **Titanium Suture Anchor**, diameter 6.5 mm, length 12.5 mm, with two MEGAFIBRE® threads USP 2, pre-assembled, self-tapping, with inserter, sterile, for single use

Note:

Suture Anchors 2870309 ST, 2870514 TI and 2870614 TI are used in combination with Bone Punch 28179 KS. For further information, see ARTHROSCOPY AND SPORTS MEDICINE catalog



For use with Inserters 28179 TK/TI/KI

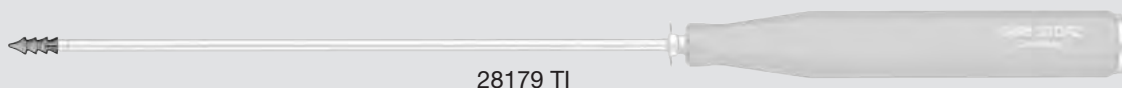

28179 TI

BIOPLUG, bioresorbable suture anchors, sterile, for single use

	Order No.	Diameter	Length	Instruments	
	2870310 BP with one MEGAFIBRE® USP 2 suture preloaded	3.5 mm	10 mm	Inserter 28179 TK Drill 28179 TD Glenoid Guide 28179 GG Mallet 28270 H	
	2870411 BP	4.2 mm	11 mm	Knee Inserter 28179 KI Drill 28179 KB Mallet 28270 H	Shoulder Inserter 28179 TI Drill 28179 TB Mallet 28270 H Glenoid Guide 28179 GG
	2870514 BP	5.2 mm	14 mm	Inserter 28179 TI Drill 28179 TC Mallet 28270 H	



For use with Handle 26 5200 43 in conjunction with
AUTOCON® II 200

STERILE



26 5200 43



28801 EA **Arthroscopy HF Ball Electrode**, diameter 2.6 mm,
ball diameter 2.5 mm, working length 6 cm,
sterile, for single use, package of 5

28801 EB **Same**, working length 11 cm



28801 EC **Arthroscopy HF Ball Electrode**, diameter 2.6 mm,
ball diameter 3.5 mm, working length 6 cm,
sterile, for single use, package of 5

28801 ED **Same**, working length 11 cm

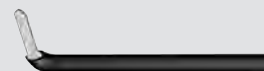

28801 EF **Arthroscopy HF Hook Electrode**, diameter 2.6 mm,
electrode length 2.8 mm, working length 6 cm,
sterile, for single use, package of 5

28801 EG **Same**, working length 11 cm

28801 EH **Arthroscopy HF Hook Electrode**, diameter 2.6 mm,
electrode length 4 mm, working length 11 cm,
sterile, for single use, package of 5



For use with Sagittal Saw Attachment 28 7210 39 and Multifunction Handle 28 7210 36 in conjunction with UNIDRIVE® S III ARTHRO SCB



28 7210 39



28207 SLA

28207 SLA **Saw Blade**, blade width 10 mm, blade thickness 0.4 mm, cutting thickness 0.6 mm, working length 50 mm, unsterile, for single use



28207 SLB

28207 SLB **Same**, blade width 14 mm



28207 SLC

28207 SLC **Saw Blade**, blade width 10 mm, blade thickness 0.4 mm, cutting thickness 0.6 mm, with stopper at 15 mm, working length 25 mm, unsterile, for single use



28207 SLD

28207 SLD **Same**, blade width 6 mm



28207 SLE

28207 SLE **Same**, blade width 8 mm

Saw Blades



For use with Sagittal Saw Attachment 28 7210 39 and Multifunction Handle 28 7210 36 in conjunction with UNIDRIVE® S III ARTHRO SCB



28 7210 39



28207 SLF

28207 SLF

Saw Blade, blade width 12 mm, blade thickness 0.4 mm, cutting thickness 0.6 mm, working length 22 mm, unsterile, for single use



28207 SLG

28207 SLG

Saw Blade, blade width 6 mm, blade thickness 0.4 mm, cutting thickness 0.6 mm, working length 31 mm, unsterile, for single use



28207 SLH

28207 SLH

Same, blade width 10 mm

Tubing Sets

for irrigation and suction



Special Features:

- Optical product recognition thanks to clear color coding (red or blue)



For use with ARTHROPUMP® Power

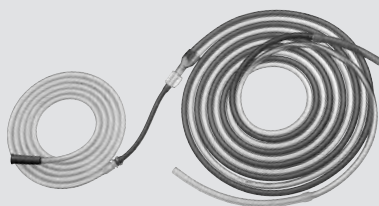

031228-10



031328-10

031228-10 **Tubing Set for Suction**, with two suction tubes, sterile, for single use, package of 10, for use with ARTHROPUMP® Power

031328-10 **Tubing Set for Irrigation**, with two puncture cannulas, sterile, for single use, package of 10, for use with ARTHROPUMP® Power

Tubing Sets

Pump Tubing Day Set and Patient Tube



Special Features:

- Optical product recognition thanks to clear color coding (red or blue)

For use with ARTHROPUMP® Power



031261-10

STERILE

031261-10 **Pump Tubing Day Set**, for irrigation, with two puncture cannulas, sterile, package of 10, for use with ARTHROPUMP® Power in combination with Patient Tube 031162-10

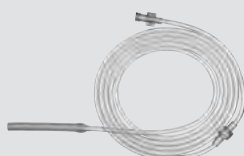

031162-10

STERILE

031162-10 **Patient Tube**, sterile, for single use, package of 10, for use with Pump Tubing Day Set 031161-10, 031167-10, 031168-10, 031261-10 and 031767-10

Tubing Sets

Irrigation Tubing Sets



Special Features:

- No risk of confusion when placing the connectors
- Automatic product recognition and mode selection via the pump

For use with ENDOMAT® SELECT



031523-10

031523-10 **Tubing Set for Irrigation**, PC, sterile, for single use, package of 10, for use with HAMOU® ENDOMAT® SCB 26 3311 20-1 and ENDOMAT® SELECT

Tubing Sets

Irrigation Tubing Sets



Special Features:

- Optical product matching thanks to clear color coding (white)



For use with ARTHROPUMP® SCB, ARTHROPUMP® plus

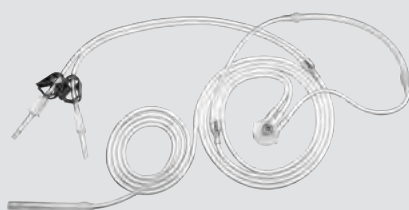

031128-10

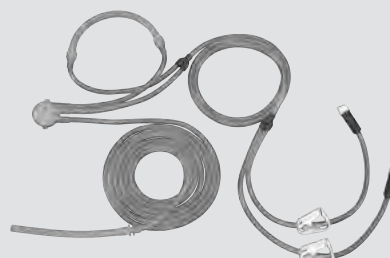

031142-10

- 031128-10 **Tubing Set**, with two puncture cannulas, sterile, for single use, package of 10, for use with ARTHROPUMP® SCB, ARTHROPUMP® plus, UROMAT and UROPUMP
- 031142-10 **Tubing Set**, with two Care-Lock connectors, sterile, for single use, package of 10, for use with ARTHROPUMP® SCB, ARTHROPUMP® plus, UROMAT and UROPUMP

Tubing Sets

Pump Tubing Day Set and Patient Tube



Special Features:

- Optical product matching thanks to clear color coding (white)

For use with ARTHROPUMP® SCB, ARTHROPUMP® plus

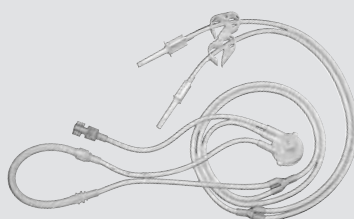

031161-10

STERILE

031161-10 **Pump Tubing Day Set**, with two puncture cannulas, sterile, package of 10, for use with ARTHROPUMP® SCB, ARTHROPUMP® plus, UROMAT and UROPUMP in combination with Patient Tube 031162-10

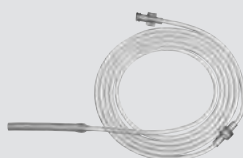

031162-10

STERILE 

031162-10 **Patient Tube**, sterile, for single use, package of 10, for use with Pump Tubing Day Set 031161-10, 031167-10, 031168-10, 031261-10 and 031767-10



SPINE SURGERY

HIGH-SPEED BURRS, BURRS 202-207

TUBING SETS 208-209

High-Speed Burrs

High-Speed Standard Burrs



For use with High-Speed Handpieces 252680 short, 252681 medium and 252682 long



252681

 Diameter in mm	High-Speed Standard Burr, 100,000 rpm, sterile, for single use, package of 5		
	short	medium	long
1	350110 S	350110 M	—
2	350120 S	350120 M	350120 L
3	350130 S	350130 M	350130 L
4	350140 S	350140 M	350140 L
5	350150 S	350150 M	350150 L
6	350160 S	350160 M	350160 L
7	350170 S	350170 M	350170 L

High-Speed Burrs

High-Speed Coarse Diamond Burrs



For use with High-Speed Handpieces 252680 short, 252681 medium and 252682 long



Diameter in mm	High-Speed Diamond Burr, 100,000 rpm, sterile, for single use, package of 5		
	short	medium	long
1	350210 S	350210 M	—
2	350220 S	350220 M	350220 L
3	350230 S	350230 M	350230 L
4	350240 S	350240 M	350240 L
5	350250 S	350250 M	350250 L
6	350260 S	350260 M	350260 L
7	350270 S	350270 M	350270 L

Diameter in mm	High-Speed Coarse Diamond Burr, 100,000 rpm, sterile, for single use, package of 5		
	short	medium	long
3	350330 S	350330 M	350330 L
4	350340 S	350340 M	350340 L
5	350350 S	350350 M	350350 L
6	350360 S	350360 M	350360 L
7	350370 S	350370 M	350370 L

High-Speed Burrs

High-Speed Standard Burrs



For use with High-Speed Handpieces 252660 extra short, 252661 short, 252662 medium, 252663 long, 252690 extra short, 252691 short and 252692 medium



252661

	High-Speed Standard Burr, 60,000 rpm, sterile, for single use, package of 5			
	extra short	short	medium	long
Diameter in mm				
1	330110 ES	330110 S	330110 M	—
2	330120 ES	330120 S	330120 M	330120 L
3	330130 ES	330130 S	330130 M	330130 L
4	330140 ES	330140 S	330140 M	330140 L
5	330150 ES	330150 S	330150 M	330150 L
6	330160 ES	330160 S	330160 M	330160 L
7	330170 ES	330170 S	330170 M	330170 L

High-Speed Burrs

High-Speed Diamond Burrs



For use with High-Speed Handpieces 252660 extra short, 252661 short, 252662 medium, 252663 long, 252690 extra short, 252691 short and 252692 medium



	High-Speed Diamond Burr, 60,000 rpm, sterile, for single use, package of 5			
	Diameter in mm	extra short	short	medium
0.6	330206 ES	330206 S	–	–
1	330210 ES	330210 S	330210 M	–
1.5	330215 ES	330215 S	–	–
2	330220 ES	330220 S	330220 M	330220 L
3	330230 ES	330230 S	330230 M	330230 L
4	330240 ES	330240 S	330240 M	330240 L
5	330250 ES	330250 S	330250 M	330250 L
6	330260 ES	330260 S	330260 M	330260 L
7	330270 ES	330270 S	330270 M	330270 L

	High-Speed Coarse Diamond Burr, 60,000 rpm, sterile, for single use, package of 5			
	Diameter in mm	extra short	short	medium
3	330330 ES	330330 S	330330 M	330330 L
4	330340 ES	330340 S	330340 M	330340 L
5	330350 ES	330350 S	330350 M	330350 L
6	330360 ES	330360 S	330360 M	330360 L
7	330370 ES	330370 S	330370 M	330370 L

High-Speed Burrs

High-Speed Diamond Burrs



For use with High-Speed Handpieces 252671 extra long and 252672 super long

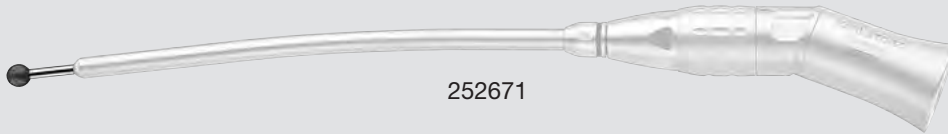

252671

Diameter in mm	High-Speed Diamond Burr, 60,000 rpm, sterile, for single use, package of 5	
	extra long	super long
2	320220 EL	320220 SL
3	320230 EL	320230 SL
4	320240 EL	320240 SL

Diameter in mm	High-Speed Coarse Diamond Burr, 60,000 rpm, sterile, for single use, package of 5	
	extra long	super long
2	320320 EL	320320 SL
3	320330 EL	320330 SL
4	320340 EL	320340 SL

Burrs

for use with DRILLCUT-X® II Spine Handpiece



For use with UNIDRIVE® S III NEURO SCB and
DRILLCUT-X® II Spine Handpiece 28 7120 50

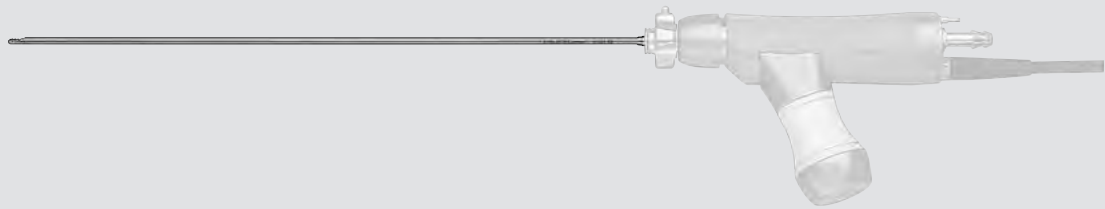

28 7120 50

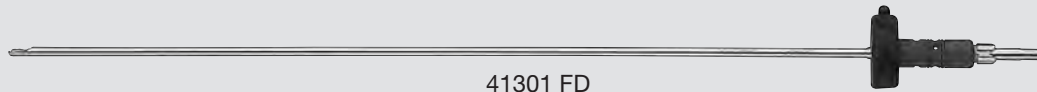

41301 FD



41301 FD

Suction Burr, with integrated irrigation, straight, cylindrical cutter head with lateral and distal protection, shaft diameter 3.5 mm, length 30 cm, sterile, for single use, package of 5, for use with DRILLCUT-X® II Spine Handpiece 28 7120 50



41301 D

Diamond Burr, with integrated irrigation, straight, diamond head, shaft diameter 3.5 mm, length 30 cm, sterile, for single use, package of 5, for use with DRILLCUT-X® II Spine Handpiece 28 7120 50

Tubing Sets

Irrigation Tubing Sets



Special Features:

- No risk of confusion when placing the connectors
- Automatic product recognition and mode selection via the pump

For use with ENDOMAT® SELECT



031523-10

031523-10 **Tubing Set for Irrigation**, PC, sterile, for single use, package of 10, for use with HAMOU® ENDOMAT® SCB 26 3311 20-1 and ENDOMAT® SELECT

Tubing Sets

Irrigation Tubing Sets



For use with CLEARVISION®, UNIDRIVE® II plus, UNIDRIVE® ENT/ECO/NEURO, UNIDRIVE® S III ENT/ECO/NEURO and/or CLEARVISION® II

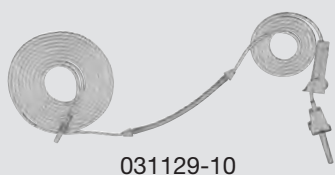

031129-10

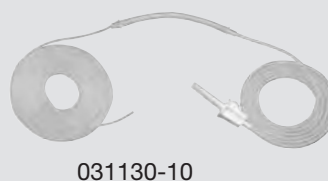

031130-10



031131-10



031229-10

- 031129-10 **Tubing Set**, sterile, for single use, package of 10, for use with CLEARVISION®
- 031130-10 **Tubing Set**, sterile, for single use, package of 10, for use with UNIDRIVE® II plus
- 031131-10 **Tubing Set**, sterile, for single use, package of 10, for use with UNIDRIVE® ENT/ECO/NEURO, UNIDRIVE® S III ENT/ECO/NEURO
- 031229-10 **Tubing Set**, sterile, for single use, package of 10, for use with CLEARVISION® II



MICROSCOPY

COVERS FOR CONTROL ELEMENTS
AND HOLDING SYSTEMS 212

TOUCH SCREEN
COVERS 213

COVER FOR VITOM® 3D 214

Covers for

for Control Elements and Holding Systems



For use with PC mice and remote controls, IMAGE1 PILOT as well as mechanical holding systems, VERSACRANE™, POINT SETTER and ENDOCRANE®



040146-25 **Cover**, 13 x 242 cm, sterile, for single use, package of 25, for use with PC mice, remote controls and ENDOCRANE® holding arm



041150-20 **Cover**, elasticated, 42 x 164 cm, sterile, for single use, package of 20, for use with holding systems and IMAGE1 PILOT

Covers

Touch Screen Covers



For use with KARL STORZ Monitors

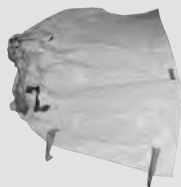

041165-20 **Cover**, sterile, for single use, package of 20, for use with 15" touch screen



041265-20 **Cover**, sterile, for single use, package of 20, for use with 18" and 19" touch screens



041365-20 **Cover**, sterile, for single use, package of 20, for use with 21.5" touch screen

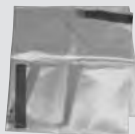

041465-20 **Cover**, sterile, for single use, package of 20, for use with 24" touch screen

Cover
for VITOM® 3D



For use with VITOM® 3D

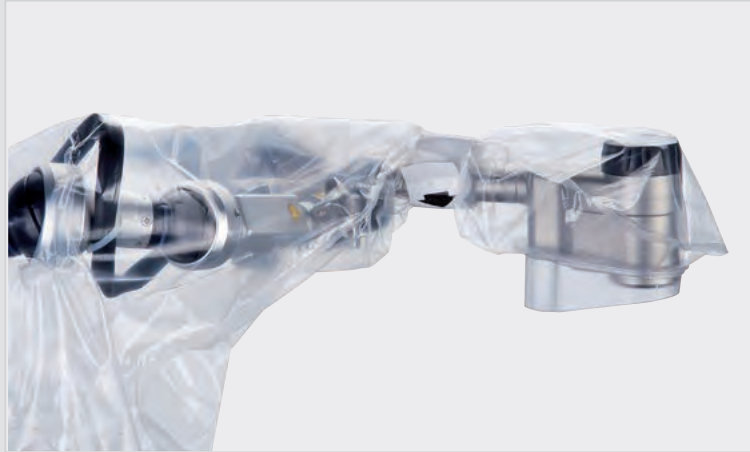

TH 001

TH 001 **Cover**, for VITOM® 3D, sterile, for single use,
package of 10



TELEPRESENCE

COVERS FOR CONTROL ELEMENTS
AND HOLDING SYSTEMS 216

TOUCH SCREEN
COVERS 217

CAMERA COVERS 218-219

Covers

for Control Elements and Holding Systems



For use with PC mice and remote controls, IMAGE1 PILOT as well as mechanical holding systems, VERSACRANE™, POINT SETTER and ENDOCRANE®



040146-25 **Cover**, 13 x 242 cm, sterile, for single use, package of 25, for use with PC mice, remote controls and ENDOCRANE® holding arm



041150-20 **Cover**, elasticated, 42 x 164 cm, sterile, for single use, package of 20, for use with holding systems and IMAGE1 PILOT

Covers

Touch Screen Covers



For use with KARL STORZ Monitors

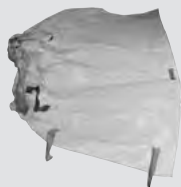

041165-20 **Cover**, sterile, for single use, package of 20, for use with 15" touch screen



041265-20 **Cover**, sterile, for single use, package of 20, for use with 18" and 19" touch screens



041365-20 **Cover**, sterile, for single use, package of 20, for use with 21.5" touch screen

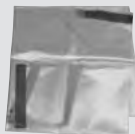

041465-20 **Cover**, sterile, for single use, package of 20, for use with 24" touch screen



For use with all standard endoscopic camera heads



040112-40 **Camera Cover**, folded inside out, 13 x 242 cm, sterile, for single use, package of 40, for use with all standard endoscopic camera heads



040113-50 **Camera Cover**, telescopic folding with paper insertion aid, 13 x 242 cm, sterile, for single use, package of 50, for use with all standard endoscopic camera heads



040114-15 **Camera Cover**, rolled, with plastic insertion aid, 17 x 242 cm, sterile, for single use, package of 15, for use with all standard endoscopic camera heads



040115-40 **Camera Cover**, telescope folding with cardboard insertion aid, 13 x 242 cm, sterile, for single use, package of 40, for use with all standard endoscopic camera heads

Covers

Camera Covers



For use with all standard endoscopic camera heads



040169-40

Camera Cover, with elastic telescope opening, telescope folding with paper insertion aid, 13 x 242 cm, sterile, for single use, package of 40, for use with all standard endoscopic camera heads

For use with all standard endoscopic camera heads as well as Video Mediastinoscopes 10970 MV, 10971 MV and 10971 MVS



040170-25

Camera Cover, with elastic telescope opening, telescope folding with paper insertion aid, 18 x 242 cm, sterile, for single use, package of 25, for use with all standard endoscopic camera heads as well as Video Mediastinoscopes 10970 MV, 10971 MV and 10971 MVS



UNITS AND ACCESSORIES

LASER FIBERS 222

INSUFFLATION TUBING SETS,
GAS FILTER AND ACCESSORIES,
SMOKE EVACUATION 223-229

TUBING SETS,
ACCESSORIES FOR IRRIGATION
AND SUCTION 230-248

BACTERIAL FILTER 249

COLLECTION SYSTEM 250-255

SPARE PARTS AND
ACCESSORIES 256-257

NEUTRAL ELECTRODES 258



For use with CALCULASE II

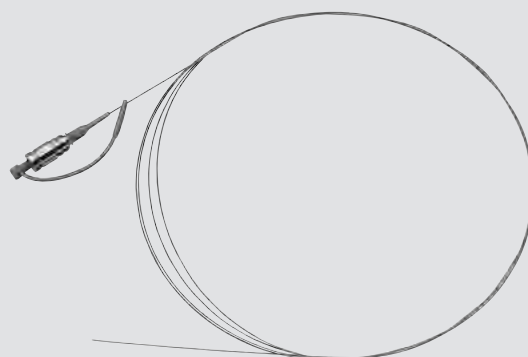

27 7502 77

27 7502 77-P6 CALCULASE II Fiber 230 μm , length 300 cm, sterile, for single use, package of 6

27 7502 78-P6 CALCULASE II Fiber 365 μm , length 300 cm, sterile, for single use, package of 6

27 7502 79-P6 CALCULASE II Fiber 600 μm , length 300 cm, sterile, for single use, package of 6

27 7502 86 CALCULASE II Fiber Kit

including:

3x **CALCULASE II Fiber 230 μm** , sterile, for single use

3x **CALCULASE II Fiber 365 μm** , sterile, for single use

3x **CALCULASE II Fiber 600 μm** , sterile, for single use

Insufflation Tubing Sets, Gas Filter and Accessories



Special Features:

- Protects patients and equipment against contamination
- Gas flow of up to 50 l/min
- Preheated gas for better view and patient comfort (031210-10)



For use with electronic ENDOFLATOR®, THERMOFLATOR®, ENDOFLATOR® 40 and ENDOFLATOR® 50



031122-25



031200-10



031210-10

- 031122-25 **Gas Filter**, with ISO connectors, hydrophobic on both sides, sterile, for single use, package of 25, for use with insufflation units with a maximum gas flow of 50 l/min (Electronic ENDOFLATOR®, THERMOFLATOR®, ENDOFLATOR® 40 and ENDOFLATOR® 50)
- 031200-10 **Insufflation Tubing Set with Gas Filter**, length 300 cm, hydrophobic on both sides, sterile, for single use, package of 10, for use with insufflation units with a maximum gas flow of 50 l/min (Electronic ENDOFLATOR®, THERMOFLATOR®, ENDOFLATOR® 40 and ENDOFLATOR® 50)
- 031210-10 **Insufflation Tubing Set with Gas Filter**, length 300 cm, heatable, hydrophobic on both sides, sterile, for single use, package of 10, for use with ENDOFLATOR® 50

Insufflation Tubing Sets, Gas Filter and Accessories



Special Features:

- Protects patients and equipment against contamination
- Two patient-side tubing connectors for gas flow up to 20 l/min with LUER-Lock
- Possible to use only one tubing connector by using a roller clamp

For use with electronic ENDOFLATOR®, THERMOFLATOR®, ENDOFLATOR® 40 and ENDOFLATOR® 50

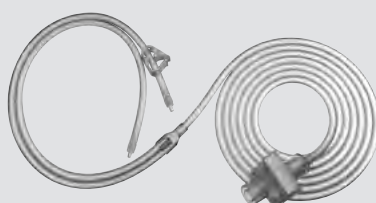

031622-10

031622-10 **Insufflation Tubing Set with Gas Filter**, length 400 cm, two patient-side tube connections, hydrophobic on both sides, sterile, for single use, package of 10, for use with insufflation units with a maximum gas flow of 30 l/min (Electronic ENDOFLATOR®, THERMOFLATOR®, ENDOFLATOR® 40 and ENDOFLATOR® 50)

Insufflation Tubing Sets, Gas Filter and Accessories



Special Features:

- Protects patients and equipment against contamination
- Gas flow of up to 30 l/min

For use with electronic ENDOFLATOR® and THERMOFLATOR®

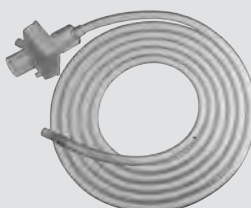

031222-10

STERILE

031222-10 **Insufflation Set with Gas Filter**, length 320 cm, hydrophobic on both sides, sterile, for single use, package of 10, for use with insufflation units with a maximum gas flow of 30 l/min (Electronic ENDOFLATOR®, THERMOFLATOR®)

including:
10x **Gas Filter with Insufflation Tube**, sterile
Adaptor with Tube
Adaptor

Accessories

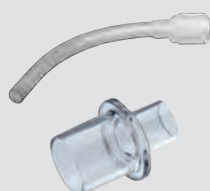

031822-01 **Adaptor**, with 15 cm tube, unsterile, for use with Filters 031122-25 and 031222-10 in combination with insufflation units without ISO connectors

031922-10 **Adaptor**, size 15M/22M, unsterile, package of 10, for use with Filters 031122-25 and 031222-10 for THERMOFLATOR® when using the OPTITHERM® heating element

NON
STERILE



For use with HAMOU® MICRO HYSTEROFLATOR® SCB

STERILE 



031123-10

031123-10 **Gas Filter**, for fluid irrigation, with male LUER-Lock connector and female LUER-Lock connector, sterile, for single use, package of 10, for use with insufflation units with a maximum gas flow of 1 l/min (HAMOU® MICRO HYSTEROFLATOR SCB)

Insufflation Tubing Sets, Gas Filter and Accessories



Special Features:

- Protects patients and equipment against contamination
- Patient- or unit-side connection possible



For use with ARTHROFLATOR®, CO₂ ENDOFLATOR®, electronic ENDOFLATOR®, N₂O ENDOFLATOR® and LAPAROFLATOR®



031121-10

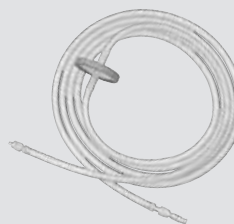

031221-10

031121-10 **Gas Filter**, with patient-side tube and male Luer-Lock, hydrophobic on both sides, sterile, for single use, package of 10, for use with insufflation units with a maximum gas flow of 10 l/min (ARTHROFLATOR®, CO₂ ENDOFLATOR®, Electronic ENDOFLATOR®, N₂O ENDOFLATOR® and LAPAROFLATOR®)

031221-10 **Insufflation Tubing Set with Gas Filter**, length 300 cm, with male and female Luer-Locks, hydrophobic on both sides, sterile, for single use, package of 10, for use with insufflation units with a maximum gas flow of 10 l/min (ARTHROFLATOR®, CO₂ ENDOFLATOR®, Electronic ENDOFLATOR®, N₂O ENDOFLATOR® and LAPAROFLATOR®)

Smoke Evacuation

Tubing Set



Special Features:

- Connector for second suction tube for parallel suction of fluids
- Roller clamp for regulating the suction pressure of smoke and gas

For use with S-PILOT®



031447-10

031447-10 **Tubing Set for Smoke, Gas and Fluid Suction**, with connector for second suction tube, sterile, for single use, package of 10, for use with S-PILOT®, for laparoscopy

Smoke Evacuation

Smoke Evacuation Filter



Special Features:

- Effective filtration at a rate of 99.9999 %
- Protects the patient and the surgical team against viruses, bacteria and harmful particles



For use with S-PILOT®



031111-10

031111-10 **Smoke Evacuation Filter**, unsterile,
for single use, package of 10

Tubing Sets

for irrigation and suction



Special Features:

- **Monobloc connector eliminates confusion between irrigation and suction ports**



For use with B.I.O.H.[®] Compact Hysteroscope 26252 BB/BC/BH in combination with HAMOU[®] ENDOMAT[®] 26 3310 20 and/or HYSTEROMAT E.A.S.I.[®] SCB



031317-10



031262-10

031317-10 **Tubing Set**, with Monobloc connector and irrigation and suction tube, sterile, for single use, package of 10, for use with B.I.O.H.[®] Compact Hysteroscopes 26252 BB/BC/BH in combination with HAMOU[®] ENDOMAT[®] 26 3310 20 (connection to pump only with Pump Tubing Day Set 031167-10)

031262-10 **Tubing Set**, with Monobloc connector, sterile, for single use, package of 10, for use with B.I.O.H.[®] Compact Hysteroscopes 26252 BB/BC/BH in combination with HYSTEROMAT E.A.S.I.[®] SCB (for use with Tubing Day Sets 031267-01, 031767-01)

Tubing Sets

for irrigation and suction



For use with HAMOU® ENDOMAT® 26 3310 20 and/or ENDOMAT® LC SCB



031218-10



031219-10

- 031218-10 **Complete Tubing Set**, with two puncture cannulas, sterile, for single use, package of 10, for use with Handles 37112 A (straight) and 37113 A (pistol grip) as well as 37112 RV in combination with HAMOU® ENDOMAT® 26 3310 20, for laparoscopy
- 031219-10 **Complete Tubing Set**, with two puncture cannulas, sterile, for single use, package of 10, for use with Handles 37112 A (straight) and 37113 A (pistol grip) as well as 37112 RV in combination with ENDOMAT® LC SCB

Tubing Sets

for irrigation and suction



Special Features:

- Optical product matching thanks to clear color coding (red and blue)



For use with HYSTEROMAT E.A.S.I.® SCB and UROMAT E.A.S.I.® SCB

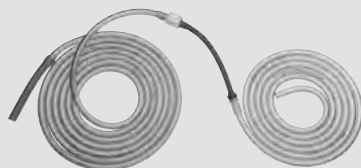

031217-10



031717-10

- 031217-10 **Tubing Set for Suction**, sterile, for single use, package of 10, for use with HYSTEROMAT E.A.S.I.® SCB and UROMAT E.A.S.I.® SCB
- 031717-10 **Tubing Set for Irrigation**, with two puncture cannulas, sterile, for single use, package of 10, for use with HYSTEROMAT E.A.S.I.® SCB and UROMAT E.A.S.I.® SCB

Tubing Sets

Pump Tubing Day Set and Patient Tube



Special Features:

- Optical product matching thanks to clear color coding (red and blue)

For use with HYSTEROMAT E.A.S.I.® SCB and UROMAT E.A.S.I.® SCB



031767-10

STERILE

031767-10 **Pump Tubing Day Set**, with two puncture cannulas, sterile, package of 10, for use with HYSTEROMAT E.A.S.I.® SCB and UROMAT E.A.S.I.® SCB in combination with Patient Tubes 031162-10 and 031262-10

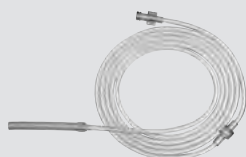

031162-10



031262-10

STERILE

031162-10 **Patient Tube**, sterile, for single use, package of 10, for use with Pump Tubing Day Set 031161-10, 031167-10, 031168-10, 031261-10 and 031767-10

031262-10 **Tubing Set**, with Monobloc connector, sterile, for single use, package of 10, for use with B.I.O.H.® Compact Hysteroscopes 26252 BB/BC/BH in combination with HYSTEROMAT E.A.S.I.® SCB (for use with Tubing Day Sets 031267-01, 031767-01)

Tubing Sets

Pump Tubing Day Set and Patient Tube



Special Features:

- Optical product matching thanks to clear color coding (red and blue)



For use with HYSTEROMAT E.A.S.I.® SCB



031267-10



- 031267-10 **Tubing Set**, day set for suction, unsterile, package of 10, for use with HYSTEROMAT E.A.S.I.® SCB (for use with Tubing Set 031262-10)



031262-10



- 031262-10 **Tubing Set**, with Monobloc connector, sterile, for single use, package of 10, for use with B.I.O.H.® Compact Hysteroscopes 26252 BB/BC/BH in combination with HYSTEROMAT E.A.S.I.® SCB (for use with Tubing Day Sets 031267-01, 031767-01)

Tubing Sets

for irrigation and suction



Special Features:

- No risk of confusion when placing the connectors
- Automatic product recognition and mode selection via the pump



For use with ENDOMAT® SELECT and/or HAMOU® ENDOMAT® SCB 26 3311 20-1

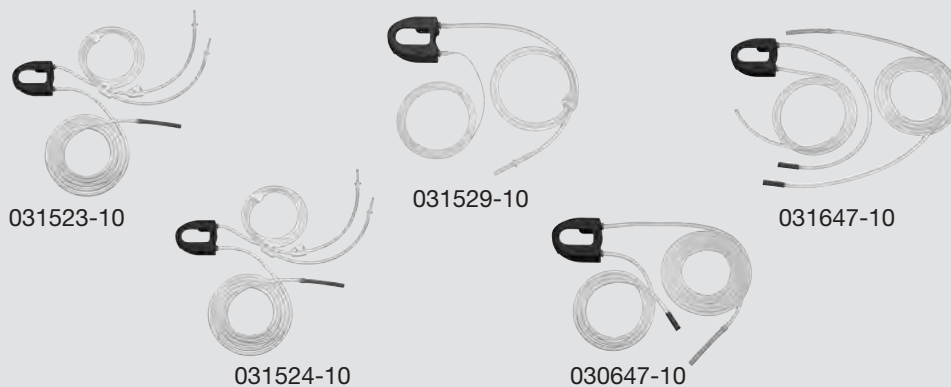

- 031523-10 **Tubing Set for Irrigation, PC, sterile, for single use, package of 10, for use with HAMOU® ENDOMAT® SCB 26 3311 20-1 and ENDOMAT® SELECT**
- 031524-10 **Tubing Set for Irrigation, FC, sterile, for single use, package of 10, for use with HAMOU® ENDOMAT® SCB 26 3311 20-1 and ENDOMAT® SELECT**
- 031529-10 **Tubing Set for Irrigation, CV, sterile, for single use, package of 10, for use with ENDOMAT® SELECT**
- 030647-10 **Tubing Set for Suction, DS, sterile, for single use, package of 10, for use with ENDOMAT® SELECT**
- 031647-10 **Tubing Set for Suction, BS, sterile, for single use, package of 10, for use with ENDOMAT® SELECT**

Tubing Sets

Irrigation Tubing Sets



Special Features:

- Optical product matching thanks to clear color coding (blue)
- Automatic product recognition and mode selection via the pump (HYS mode)

For use with HAMOU® ENDOMAT® 26 3310 20 for hysteroscopy and HYSTEROMAT® II

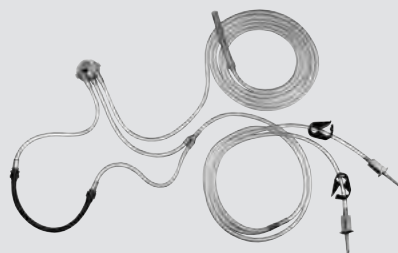

031117-10



031140-10

031117-10 **Tubing Set for Irrigation**, with two puncture cannulas, sterile, for single use, package of 10, for use with HAMOU® ENDOMAT® 26 3310 20, for hysteroscopy and HYSTEROMAT® II

031140-10 **Tubing Set**, with two Care-Lock connectors, sterile, for single use, package of 10, for use with HAMOU® ENDOMAT® 26 3310 20, for hysteroscopy and HYSTEROMAT® II

Tubing Sets

Pump Tubing Day Set and Patient Tube



Special Features:

- Optical product matching thanks to clear color coding (blue)
- Automatic product recognition and mode selection via the pump (HYS mode)

STERILE

For use with HAMOU® ENDOMAT® 26 3310 20 for hysteroscopy and HYSTEROMAT® II

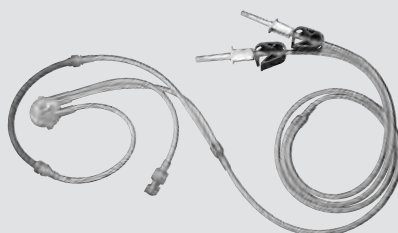

031167-10

STERILE

031167-10 **Pump Tubing Day Set**, with two puncture cannulas, sterile, package of 10, for use with HAMOU® ENDOMAT® 26 3310 20, for hysteroscopy and HYSTEROMAT® II, in combination with Patient Tube 031162-10



031162-10

STERILE

031162-10 **Patient Tube**, sterile, for single use, package of 10, for use with Pump Tubing Day Set 031161-10, 031167-10, 031168-10, 031261-10 and 031767-10

Tubing Sets

Irrigation Tubing Sets



Special Features:

- Optical product matching thanks to clear color coding (red)
- Automatic product recognition and mode selection via the pump (LAP mode)

For use with HAMOU® ENDOMAT® 26 3310 20 and/or LAPAROMAT®



031118-10



031141-10



031159-10

- 031118-10 **Tubing Set**, with two puncture cannulas, sterile, for single use, package of 10, for use with HAMOU® ENDOMAT® 26 3310 20, for laparoscopy
- 031141-10 **Tubing Set**, with two Care-Lock connectors, sterile, for single use, package of 10, for use with HAMOU® ENDOMAT® 26 3310 20, for laparoscopy
- 031159-10 **Tubing Set**, with two puncture cannulas, sterile, for single use, package of 10, for use with LAPAROMAT®, for laparoscopy

Tubing Sets

Pump Tubing Day Set and Patient Tube



Special Features:

- Optical product matching thanks to clear color coding (red)
- Automatic product recognition and mode selection via the pump (LAP mode)

For use with HAMOU® ENDOMAT® 26 3310 20



031168-10

STERILE

031168-10 **Pump Tubing Day Set**, with two puncture cannulas, sterile, package of 10, for use with HAMOU® ENDOMAT® 26 3310 20, for laparoscopy, in combination with Patient Tube 031162-10

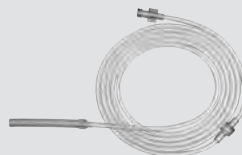

031162-10

STERILE

031162-10 **Patient Tube**, sterile, for single use, package of 10, for use with Pump Tubing Day Set 031161-10, 031167-10, 031168-10, 031261-10 and 031767-10

Tubing Sets

for irrigation and suction



Special Features:

- Optical product matching thanks to clear color coding (red and blue)



For use with ARTHROPUMP® Power

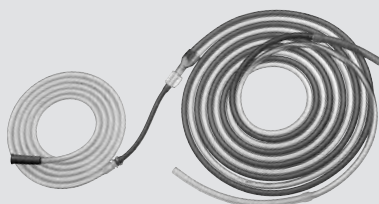

031228-10



031328-10

031228-10 **Tubing Set for Suction**, with two suction tubes, sterile, for single use, package of 10, for use with ARTHROPUMP® Power

031328-10 **Tubing Set for Irrigation**, with two puncture cannulas, sterile, for single use, package of 10, for use with ARTHROPUMP® Power

Tubing Sets

Pump Tubing Day Set and Patient Tube



Special Features:

- Optical product matching thanks to clear color coding (red and blue)

For use with ARTHROPUMP® Power



031261-10

STERILE

031261-10 **Pump Tubing Day Set**, for irrigation, with two puncture cannulas, sterile, package of 10, for use with ARTHROPUMP® Power in combination with Patient Tube 031162-10



031162-10

STERILE

031162-10 **Patient Tube**, sterile, for single use, package of 10, for use with Pump Tubing Day Set 031161-10, 031167-10, 031168-10, 031261-10 and 031767-10

Tubing Sets

Irrigation Tubing Sets



Special Features:

- Optical product matching thanks to clear color coding (white)



For use with ARTHROPUMP® SCB, ARTHROPUMP® plus, UROMAT and UROPUMP

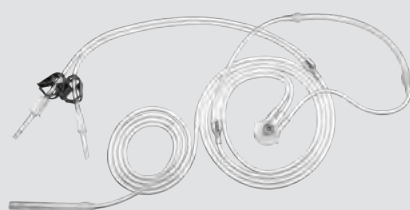

031128-10

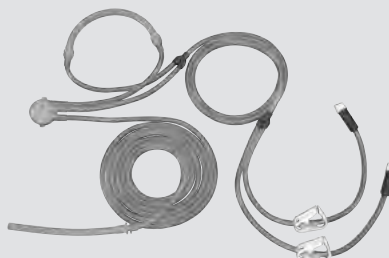

031142-10

031128-10 **Tubing Set**, with two puncture cannulas, sterile, for single use, package of 10, for use with ARTHROPUMP® SCB, ARTHROPUMP® plus, UROMAT and UROPUMP

031142-10 **Tubing Set**, with two Care-Lock connectors, sterile, for single use, package of 10, for use with ARTHROPUMP® SCB, ARTHROPUMP® plus, UROMAT and UROPUMP

Tubing Sets

Pump Tubing Day Set and Patient Tube



Special Features:

- Optical product matching thanks to clear color coding (white)

For use with ARTHROPUMP® SCB, ARTHROPUMP® plus, UROMAT and UROPUMP

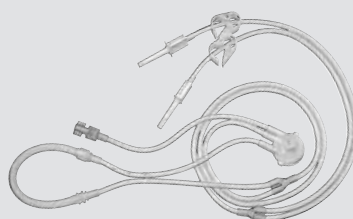

031161-10

STERILE

031161-10 **Pump Tubing Day Set**, with two puncture cannulas, sterile, package of 10, for use with ARTHROPUMP® SCB, ARTHROPUMP® plus, UROMAT and UROPUMP in combination with Patient Tube 031162-10



031162-10

STERILE

031162-10 **Patient Tube**, sterile, for single use, package of 10, for use with Pump Tubing Day Set 031161-10, 031167-10, 031168-10, 031261-10 and 031767-10

Tubing Sets

for irrigation and suction



For use with ENDOMAT® LC SCB



031119-10



031247-10

- 031119-10 **Tubing Set for Irrigation**, with two puncture cannulas, sterile, for single use, package of 10, for use with ENDOMAT® LC SCB
- 031247-10 **Tubing Set for Suction**, sterile, for single use, package of 10, for use with ENDOMAT® LC SCB

Tubing Sets

Irrigation Tubing Sets



For use with CLEARVISION®, UNIDRIVE® II plus, UNIDRIVE® ENT/ECO/NEURO, UNIDRIVE® S III ENT/ECO/NEURO and/or CLEARVISION® II

STERILE

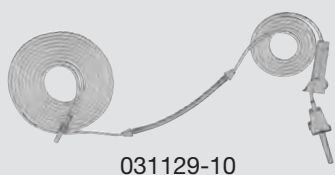

031129-10

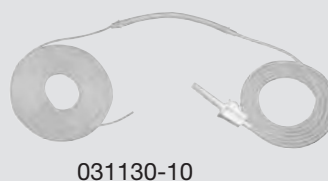

031130-10



031131-10



031229-10

- 031129-10 **Tubing Set**, sterile, for single use, package of 10, for use with CLEARVISION®
- 031130-10 **Tubing Set**, sterile, for single use, package of 10, for use with UNIDRIVE® II plus
- 031131-10 **Tubing Set**, sterile, for single use, package of 10, for use with UNIDRIVE® ENT/ECO/NEURO, UNIDRIVE® S III ENT/ECO/NEURO
- 031229-10 **Tubing Set**, sterile, for single use, package of 10, for use with CLEARVISION® II

Tubing Sets

for irrigation and suction



Special Features:

- No risk of confusion when placing the connectors

For use with ENDOMAT® SELECT and/or HAMOU® ENDOMAT® SCB 26 3311 20-1



030547-01



- 030547-01 **Tubing Set for Suction**, 150 cm, with EXTRA-LARGE LUER-Lock, unsterile, for use with HAMOU® ENDOMAT® SCB 26 3311 20-1



031523-10



031524-10



- 031523-10 **Tubing Set for Irrigation**, PC, sterile, for single use, package of 10, for use with HAMOU® ENDOMAT® SCB 26 3311 20-1 and ENDOMAT® SELECT
- 031524-10 **Tubing Set for Irrigation**, FC, sterile, for single use, package of 10, for use with HAMOU® ENDOMAT® SCB 26 3311 20-1 and ENDOMAT® SELECT

Tubing Sets

for suction



For use with S-PILOT®

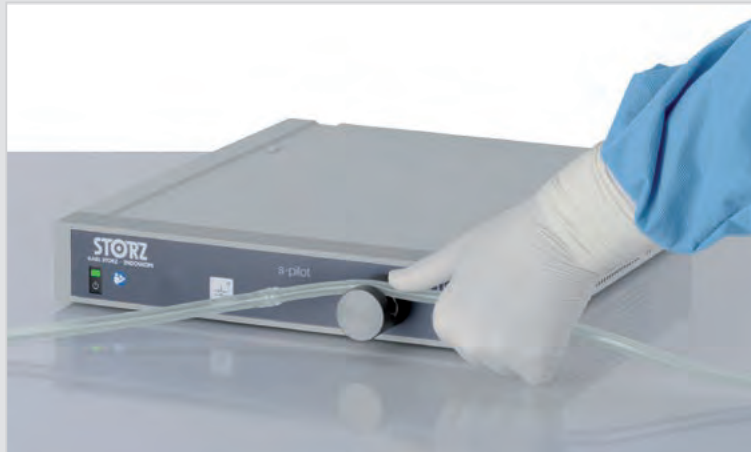

031457-10

031457-10 **Tubing Set for Suction**, sterile, for single use, package of 10, for use with S-PILOT®, for urology/gynecology

Tubing Sets

for suction



For use with UROMAT and CALCUSON

STERILE 

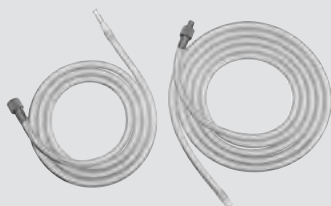

030147-10



030247-10

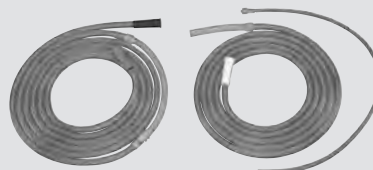

031347-10

030147-10 **Tubing Set for Suction**, sterile, for single use, package of 10, consisting of patient tube and pump tube, for use with suction and suction/irrigation pumps and Bottle Cap **20 3000 34** for suction bottles

030247-10 **Y-Tubing Set**, for suction, sterile, for single use, package of 10, for use with resectoscopes, collection bags and other suction instruments

031347-10 **Tubing Set for Suction**, sterile, for single use, package of 10, for use with UROMAT and CALCUSON

Bacterial Filter



For use with UNIMAT® 30



25 3200 80

25 3200 80 **Filter**, for suction, unsterile, for use with UNIMAT® 30

Collection System

Containers



Easy to use

The single-use collection system offers numerous advantages for straightforward use in the clinic.

The one-piece liner is simply inserted into the jar and is ready for use in seconds. As the vacuum port is located directly in the jar, the liner can be conveniently removed and replaced without having to remove the jar.

The snap-lock system holds the jar securely in place and allows easy liner replacement with only one hand.

If large amounts of secretions need to be suctioned, the system can be used with a serial connection or a special change-over valve. Logistical effort is reduced as there are only two container sizes: 1.5 and 2.5 l.

Clear color coding rules out mix-ups: Orange bag in an orange container; yellow bag in a yellow container.



030301-01 **Suction Jar, 1.5 l**



030302-01 **Secretion Container, 2.5 l**



030362-10 **Coupling Piece, package of 10**

Collection System

Suction Liners



030310-40 **Suction Liner**, 1.5 l, for single use, package of 40



030320-40 **Suction Liner**, 2.5 l, for single use, package of 40



030315-30 **Suction Liner**, 1.5 l, with solidifier, for single use, package of 30



030325-30 **Suction Liner**, 2.5 l, with solidifier, for single use, package of 30



Collection System

Tubing Sets for Suction



030248-10 **Tubing Set for Suction**, 250 cm, with male LUER-Lock, sterile, for single use, package of 10

STERILE 



030448-01 **Tubing Set for Suction**, 150 cm, unsterile, for use with pumps with ISO connectors



030547-01 **Tubing Set for Suction**, 150 cm, with EXTRA-LARGE LUER-Lock, unsterile, for use with HAMOU® ENDOMAT® SCB 26 3311 20-1



030748-20 **Tubing Set for Suction**, 170 cm, unsterile, package of 20



030948-01 **Tubing Set for Suction**, 150 cm, unsterile, for use with pumps with LUER-Lock connectors

Collection System

Tubing Sets for Serial Connection



Special Features:

- Serial connection with up to 5 canisters possible

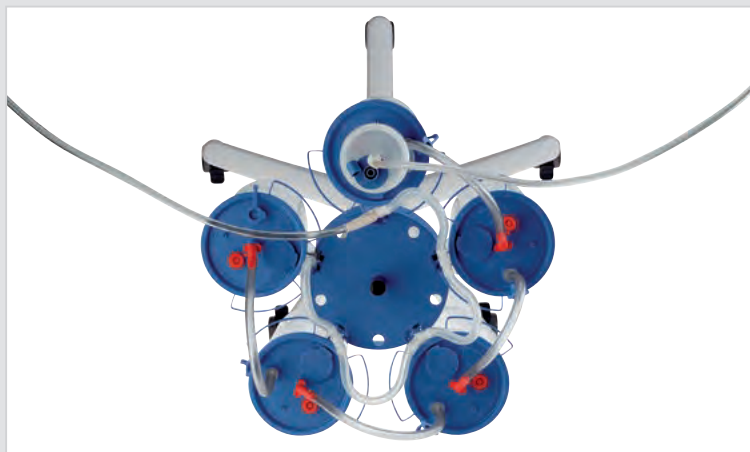

030331-100 **Serial Connection**, patient, package of 100



030332-01 **Serial Connection**, patient, 1 pc



030341-01 **Serial Connection**, vacuum



030342-01 **Vacuum Tubing**, with straight coupling piece (for single-use system)



030343-01 **Silicone Tubing**, diameter 7x12 mm, 100 cm, without coupling piece



030346-01 **Silicone Tubing**, diameter 7x12 mm, 30 cm, with coupling piece

Collection System

Accessories



030350-05 **Standard Clampholder**, plastic, package of 5



030360-10 **Y-Piece**, diameter 7 mm/diameter 5 mm, package of 10



030361-10 **Y-Piece**, diameter 7 mm, package of 10



030351-01 **Changeover Valve**, clamp holder and tubing set



030380-01 **Trolley**



030972-04 **Solidifier**, in 4 kg container with 36 g dosing spoon, for use with collection systems (consumption: 36 g/l)



030370-10 **Specimen Cup**, for collection system, unsterile, for single use, package of 10



Collection System

12 l Canister



Special Features:

- Serial connection with up to 5 canisters possible



030306-04 **Guardian Suction Canister,**
12 l, for single use, package of 4



030970-10 **Tissue Trap Filter with Adaptor,** unsterile,
for single use, package of 10, for use with
Suction Canister 030306-04 and other
suction bottle systems



030381-01 **Guardian LVC Roll Stand,**
for 1 canister, 12 l



Spare Parts and Accessories

Filter



Special Features:

- Prevents contamination and damage to the suction unit



031124-10

031124-10 **Filter**, for suction, connection on bottle side with special connection, connection on unit side with cone, for single use, package of 10, for use with all standard suction pumps with tube connections

Spare Parts and Accessories

Care-Lock Connector



For use with Tubing Sets and Puncture Cannulas



031151-100

031151-100 **Care-Lock Connector**, sterile, for single use, package of 100, for use with tubing sets with puncture cannulas

Neutral Electrode



For use with AUTOCON®

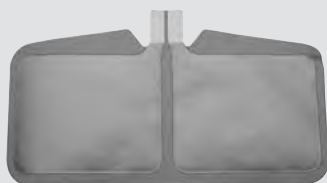

27802

27802

Neutral Electrode, contact surface divided into two, A = 169 cm², for single use, package of 50, Connecting Cable 27801 required, for use with AUTOCON® 50/200/350 and AUTOCON® II 400 all versions



NAVIGATION

BONE SCREWS 260

NAVIGATED SINUS BURRS 261

ACCESSORIES
FOR NAVIGATION 262



For use with maxDrive® bone anchor and screwdriver handle



40 8002 23



40 8002 23 maxDrive® Bone Screw, diameter 2 mm, length 7 mm, sterile, package of 3, for use with maxDrive® bone anchor and screwdriver handle



40 8002 23



40 8002 25 maxDrive® Bone Screw, diameter 2 mm, length 7 mm, unsterile, package of 5, for use with maxDrive® bone anchor and screwdriver handle

Navigated Sinus Burrs

for paranasal and skull base surgery



For use with DRILLCUT-X® II Shaver Handpiece 40 7120 50 and
DRILLCUT-X® II N Shaver Handpiece 40 7120 55

STERILE

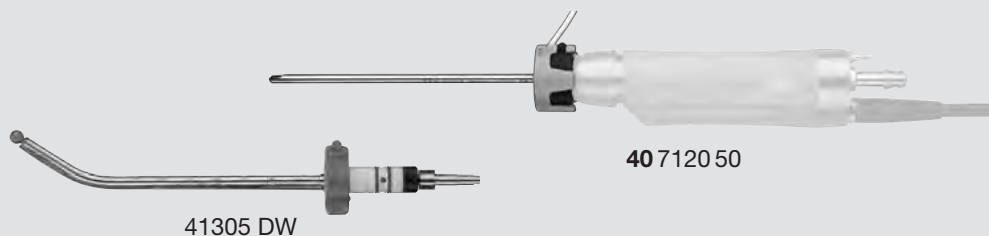

Detail	Sinus Burrs, curved 70°/40°/15°, length 12 cm, sterile, for single use, package of 5	
	41305 D	curved 15°, diamond head, drill diameter 5 mm, shaft diameter 4 mm, color code: red-yellow
	41305 DW	curved 40°, diamond head, drill diameter 5 mm, shaft diameter 4 mm, color code: red-yellow
	41303 DT	curved 70°, diamond head, drill diameter 3.6 mm, shaft diameter 4 mm, color code: red-yellow
	41335 DW	curved 40°, diamond head, drill diameter 5 mm, shaft diameter 4 mm, color code: red
	41335 DT	curved 70°, diamond head, drill diameter 3.6 mm, shaft diameter 4 mm, color code: red

Accessories

for navigation



For use with Patient Tracker



Headband

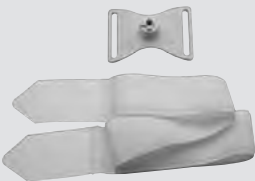

40 8000 83 **Headband for Navigation**, with plastic holder, unsterile, for single use, for use with NAV1® PICO, NAV1® OPTICAL and NAV1® ELECTROMAGNETIC

40 8002 00 **Headband for Navigation**, with plastic holder and headband, unsterile, for single use, package of 10, for use with NAV1® PICO, NAV1® OPTICAL and NAV1® ELECTROMAGNETIC



Adhesive Pad



40 8200 84 **Adhesive Pad**, sterile, for single use, package of 20, for use with EM Patient Tracker **40 8200 86** or with headband





HYGIENE

CLEANING BRUSHES 264-266



Special Features:

- Excellent hygienic safety thanks to double-sided brush and single-use product
- Rounded tips to protect the endoscope from damage



110910-50



110910-50

Cleaning Brush, with double-sided brush, length 220 cm, brush diameter 5 mm, unsterile, for single use, package of 50, for use with flexible endoscopes with working channel diameters 2.8 – 4.2 mm



110915-50

Cleaning Brush, with double-sided brush, length 220 cm, brush diameter 3 mm, unsterile, for single use, package of 50, for use with flexible endoscopes with working channel diameters 2 – 2.3 mm



110917-50

Cleaning Brush, with double-sided brush, length 220 cm, brush diameter 1.5 mm, unsterile, for single use, package of 50, for use with flexible endoscopes with a working channel diameter of 1.2 mm



110920-10

Biofilm Removal Device Cleaning Brush, flocked, length 200 cm, unsterile, for single use, package of 10, for use with flexible endoscopes with a working diameter of 1.2 mm

Cleaning Brushes



Special Features:

- Brush filaments become softer from distal to proximal to remove coarse and fine debris during each brushing process, thus reducing the risk of biofilm
- Distally conical brush head
- Distal brush head is green to ensure safe insertion of the distal end
- In the case of thin-lumened cleaning brushes, the distal brush head has been replaced by two proximally mounted brush heads to make insertion into the working channel easier
- Brush tip end ensures maximum protection of the working channel
- Clear and unambiguous identification of the working channel diameter through color coding
- Individual intermediate sizes adapted to working channel length and diameter for time-saving and hygienically safe reprocessing
- Practical dispenser box with perforated individual packaging for easy removal
- Ready for use
- User-friendly design
- Enhanced hygiene safety
- No risk of cross-contamination
- Time savings by eliminating the need to reprocess reusable cleaning brushes
- Cleaning effectiveness proven by standard regulations

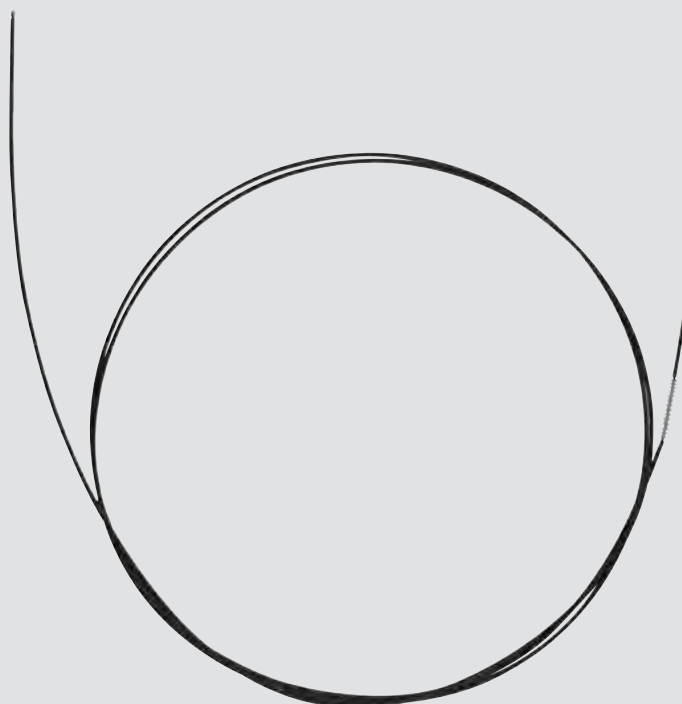

110930-50



Cleaning Brushes, for working channel sizes 1.2 – 1.5 mm:

- | | |
|-----------|--|
| 110930-50 | Biofilm Removal Device Cleaning Brush , length 90 cm, brush diameter 1.7 mm, unsterile, for single use, package of 50, for use with flexible endoscopes with working channel diameters 1.2 – 1.5 mm |
| 110931-50 | Same , length 125 cm |
| 110932-50 | Same , length 200 cm |



Cleaning Brushes, for working channel sizes 2 – 2.3 mm:

- 110940-50 **Cleaning Brush**, with double-sided brush, length 90 cm, brush diameter 2.6 mm, unsterile, for single use, package of 50, for use with flexible endoscopes with working channel diameters 2 – 2.3 mm
- 110941-50 **Same**, length 120 cm
- 110942-50 **Same**, length 160 cm

Cleaning Brushes, for working channel sizes 2.6 – 3 mm:

- 110950-50 **Cleaning Brush**, with double-sided brush, length 120 cm, brush diameter 3.2 mm, unsterile, for single use, package of 50, for use with flexible endoscopes with working channel diameters 2.6 – 3 mm
- 110951-50 **Same**, length 165 cm
- 110952-50 **Same**, length 250 cm

Cleaning Brushes, for working channel sizes 3.2 – 4.2 mm:

- 110960-50 **Cleaning Brush**, with double-sided brush, length 140 cm, brush diameter 4.5 mm, unsterile, for single use, package of 50, for use with flexible endoscopes with working channel diameters 3.2 – 4.2 mm
- 110961-50 **Same**, length 190 cm
- 110962-50 **Same**, length 230 cm

Request per Business Reply Card or per FAX

+49 (0)7461 708404 or one of KARL STORZ distribution companies
 – checkmark – provide address – send –



If there are not enough reply cards available, KARL STORZ also offers this service in the Internet:

www.karlstorz.com

Please cut out reply card!

Please send us detailed information: (please check):

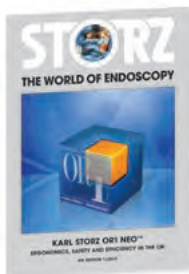

KARL STORZ OR1 NEO®

ERGONOMICS, SAFETY AND EFFICIENCY IN THE OR

We are particularly interested in:

- System integration
- Data management and documentation
- Telemedicine

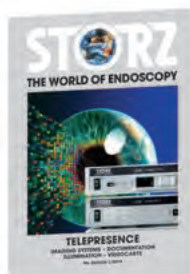

TELEPRESENCE

We are particularly interested in:

- FULL HD – New vision in medicine
- Camera systems
- Data management and documentation
- Monitors and video printers
- Light sources
- Equipment carts

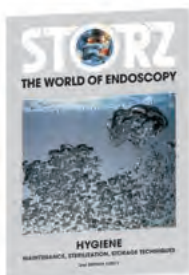

HYGIENE

CLEANING, STERILIZATION AND MAINTENANCE, STORAGE TECHNIQUES



ENDOPROTECT1

KARL STORZ SERVICE PROGRAM

We are particularly interested in:

- Repair service
- Set audits
- Training
- OR1™ service
- Hygiene
- ORCHESTRION IMM

We would like a non-binding consultancy meeting.

Appointment requested with:

Address:

Hospital/Office

Contact

Street

Postal Code

Town/City

Tel.

E-Mail



REPLY

KARL STORZ SE & Co. KG
 Postfach 230

78503 Tuttlingen/Germany

Request per Business Reply Card or per FAX

+49 (0)7461 708404 or one of KARL STORZ distribution companies
– checkmark – provide address – send –



If there are not enough reply cards available, KARL STORZ
also offers this service in the Internet:

www.karlstorz.com

Please cut out reply card!

Address:

Hospital/Office

Contact

Street

Postal Code

Town/City

Tel.

E-Mail

Postage
paid

REPLY

KARL STORZ SE & Co. KG
Postfach 230

78503 Tuttlingen/Germany

Please send us detailed information: (please check):

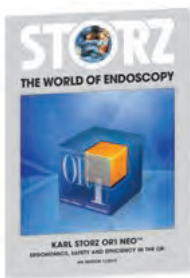

KARL STORZ OR1 NEO®

ERGONOMICS, SAFETY
AND EFFICIENCY IN THE OR

We are particularly interested in:

- System integration
- Data management and documentation
- Telemedicine

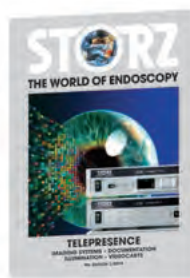

TELEPRESENCE

We are particularly interested in:

- FULL HD – New vision in medicine
- Camera systems
- Data management and documentation
- Monitors and video printers
- Light sources
- Equipment carts

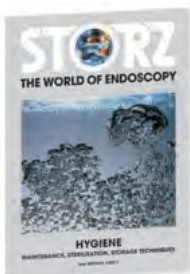

HYGIENE

CLEANING,
STERILIZATION AND
MAINTENANCE,
STORAGE TECHNIQUES



ENDOPROTECT1

KARL STORZ SERVICE PROGRAM

We are particularly interested in:

- Repair service
- Set audits
- Training
- OR1™ service
- Hygiene
- ORCHESTRION IMM

We would like a non-binding consultancy meeting.

Appointment requested with:

